



www.klauke.com

Klauke mini

made in Germany

EKWF120ML

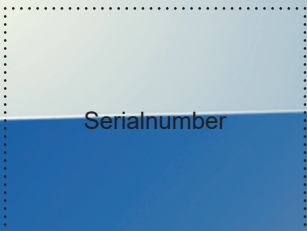

Serialnumber



HE.19869_E © 06/2021 R&D-2

Gustav Klauke GmbH • Auf dem Knapp 46 • D-42855 Remscheid • Telefon +49 2191 907 0 • www.klauke.com

Klauke

EMERSON

Wir freuen uns, dass Sie sich für ein Klauke Werkzeug entschieden haben und wünschen Ihnen viel Freude damit.

**2 Jahre
Garantie**

**Weltweiter
Werkzeug
Service
KLAUKE ASC**

Sie haben ein Qualitätsprodukt „Made in Germany“ erworben und erhalten 2 Jahre Garantie. Diese beginnt mit dem Kaufbelegdatum.

Um lange Freude und eine einwandfreie Funktion des Werkzeuges sicherzustellen, muss das Gerät spätestens beim Erreichen von 10.000 Arbeitsvorgängen oder nach 3 Jahren durch ein Autorisiertes Service Center (ASC) gewartet werden. Wird das Wartungsintervall von 10.000 Arbeitsvorgängen nicht eingehalten, erlischt der Garantieanspruch.

Im Rahmen dieser Wartung werden verschlissene Teile ersetzt und sicherheitsrelevante Teile geprüft und ggf. vorbeugend ersetzt.

Darüber hinaus empfehlen wir das Gerät jährlich zur Überprüfung an das zuständige ASC einzusenden.

Für Fragen rund um unseren Werkzeugservice oder eine Frage zu einem bestimmten Anwendungsfall stehen wir Ihnen persönlich unter der kostenlosen 0800-4685528 zur Verfügung.



Ihr Klauke Team

Thank you for choosing a Klauke tool. We hope it gives you lots of pleasure.

**2 years
Warranty**

**World wide
Tool
Service
KLAUKE ASC**

You have purchased a quality product „Made in Germany“, which is covered by a 2 year warranty. The warranty commences from the purchase receipt date.

To ensure lasting enjoyment and a flawless tool function, the product must be serviced by an Authorized Service Center (ASC) after 10,000 operations or after 3 years. Should the service Interval exceed 10.000 cycles the warranty claim is void.

The Service includes predictive maintenance in which worn-out parts will be replaced and safety relevant parts checked/replaced.

We recommend to have the tools checked yearly through an Authorized Service Center (ASC).

If you have any questions about our tool service or about a specific application, please go to <http://www.klauke.com/en/support/tool-service/>



Your Klauke team



EKWF120ML

Klauke

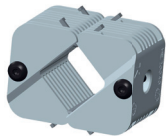

EKWF120ESET

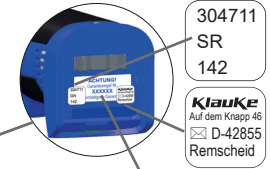

datecode

Year	Code	Month	Code	Month	Code
2021	Q	Jan.	N	July	V
2022	R	Feb.	P	Aug.	W
2023	S	Mar.	Q	Sept.	X
2024	T	Apr.	R	Oct.	Y
2025	V	May	S	Nov.	Z
2026	W	June	T	Dec.	1

batch# e.g. 304711
 datecode e.g. S = 2023; R = April
 consecutive# e.g. „142“ = tool # 142





EKWF120ML

Klauke

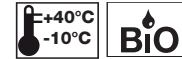
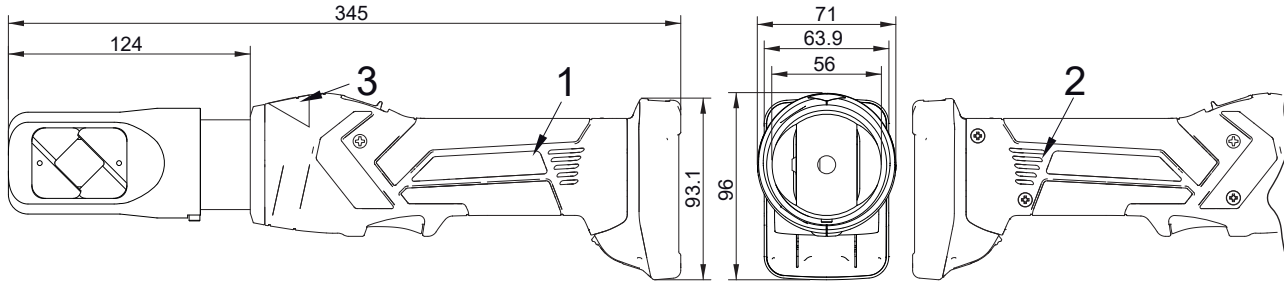

! WARNING

Read all safety warnings, instructions, illustrations and specifications provided with this power tool.

Failure to follow all instructions listed below may result in electric shock, fire and/or serious injury.

Save all warnings and instructions for future reference.

geeignet für suitable for	Verb. material Connection material	Pressbereich mm² Crimping range mm²	Press- form Crimping mold
Aderendhülsen, Zwillingsaderendhülsen (gelb chromatiert)		6 - 120	
Cable end-sleeves, Twin cable end-sleeves (chrome plated)			



General safety rules
HE.16048



EKWF120ML

Klauke



LGML1:
100-240V~
50-60Hz



LGML1
350 g

100-240V~
50-60Hz

10.8V
Li-Ion



:U	27811275410	HE.16341
:U	27811275510	HE.16347
:JK	27811275710	HE.16343
:JS	27811275210	HE.16345
:N	27811275310	
:R	05090724410	
:JP	27811275610	

Li-Ion Battery	
RAML 1	RAML 1225
1,5Ah	2,5Ah
16,2Wh	27Wh
40min	60min

Model №/모델번호: Importer/수입업체명:

LGML1 LGML1EU
 LGML1CN LGML1AU
 LGML1KR LGML1UK
 LGML1JP LGML1US

Klauke
Li-Ion Charger
Class 2 Battery Charger
SU071762-16001

Input: 100-240V~ | 50-60Hz | 35W
Output: 10.8 V= | 21.6W
Charging current: 2.0 A

WARNING
Risk of electric shock. Do not expose to liquid, vapor or rain. Charge only KLAUKE type "RAML1" rechargeable batteries. Other types of batteries may burst causing injury to persons, damage or fire.

ADVERTENCIA
Riesgo de choque eléctrico. No exponer a líquidos, vapor o lluvia. Cargar únicamente baterías recargables de tipo KLAUKE RAML1*. Otros tipos de baterías pueden explotar, causando lesiones a personas, daños o incendio.

AVERTISSEMENT
Risque de choc électrique. Ne pas exposer aux liquides, vapeurs ou pluie. Utiliser pour charger uniquement les accumulateurs KLAUKE du type RAML1*. D'autres types d'accumulateurs pourraient éclater et causer des blessures, des dommages ou feu. Lisez et observez toutes les consignes de sécurité du mode d'emploi. HE.16024_J

After sales phone №/서비스연락처: 케스코물산㈜: 02-2614-0989
 この充電器を使用する前に添付の安全上の注意や取扱説明書を注意深く読んでください | 充電器は室内でお使いください | 充電器は室内でお使いください | 充電器は室内でお使いください

Gustav Klauke GmbH
Auf dem Knapp 46
D-42855 Remscheid

JD 50344962





LGML1

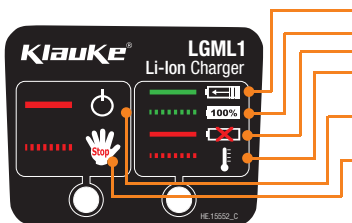

D	GB	F	E
Ladeprozess beginnt	Charger is charging	Batterie en charge	Cargando
Akku ist vollgeladen	Battery is fully charged	Charge complete	Bateria cargada completamente
Akku ist defekt	Battery is defect	Batterie défectueuse	Bateria defectuosa
Akku ist zu heiß oder zu kalt	Battery is too hot or too cold	Batterie trop chaude ou trop froide	La batería está demasiado caliente o fría
Ladegerät ist am Stromnetz angeschlossen und ladebereit	Charger is connected with the mains socket and ready to charge.	Chargeur branché à la prise de courant prêt à être chargé.	El cargador está conectado a la red y listo para cargar
Ladegerät ist defekt	Charger is defect	Chargeur défectueux	Cargador defectuoso
Achtung (1. + 2.) Bitte beachten Sie, dass der Akku aus dem Ladeschacht entnommen werden muß, wenn das Ladegerät nicht am Netz angeschlossen ist. Ansonsten wird der Akku tiefentladen!	Attention (1. + 2.) Please remove the Battery out of the charging slot if the charger is not plugged into the socket. Failing to do so might results in destroying the battery by deep discharge!	Attention (1. + 2.) Sortir la batterie du chargeur si the chargeur n'est pas branché à la prise de courant. Ceci pourrait endomager la batterie avec chute de la charge!	Atención (1. + 2.) Por favor tenga en cuenta de quitar la batería de la base de carga cuando el cargador no esté conectado a la red. De lo contrario la batería sufrirá una descarga intensa.

P	NL	RUS	PL
O carregador está em carga	laadproces begint	Идет процесс зарядки	Ładowanie zaczęte
A bateria está completamente carregada	Accu is vol geladen	Аккумулятор полностью заряжен	Akumulator naładowany w pełni
A bateria está com defeito	Accu is defect	Аккумулятор поврежден	Akumulator jest uszkodzony
A bateria está demasiado quente ou fria	Accu is te heet of te koud	Аккумулятор очень горячий или холодный	Akumulator jest za gorący lub za zimny
O carregador está ligado à corrente e pronto a carregar	lader is aangesloten aan het stromnet en klaar om te laden	Зарядное устройство подключено к сети и готово к зарядке	Ładowarka jest podłączona do sieci i gotowa do pracy
O carregador está com defeito	lader is defect	Зарядное устройство повреждено	Ładowarka jest uszkodzona
Atenção (1. + 2.) Tenha em atenção que a bateria deve ser retirada do carregador quando não estiver ligado à corrente. Se não o fizer pode resultar na destruição da bateria por descarga intensa!	Opgelet (1.+2.) Aub de accu uit de ladesleuf verwijderen als de lader niet aan het stromnet is aangesloten. Als niet kann het tot een diepontlading van de accu komen	Внимание (1 + 2) Обратите внимание, что аккумулятор нужно извлекать из зарядного устройства только если зарядное устройство отключено от сети. В противном случае может произойти полная разрядка аккумулятора.	Uwaga (1 + 2) Proszę pamiętać, że akumulator musi być usunięty ze złącza ładowarki w chwili, gdy nie jest ona podłączona do sieci. Inaczej akumulator może ulec głębokiemu rozładowaniu.



EKWF120ML

Klauke

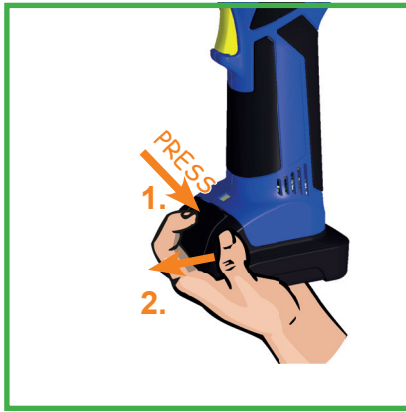
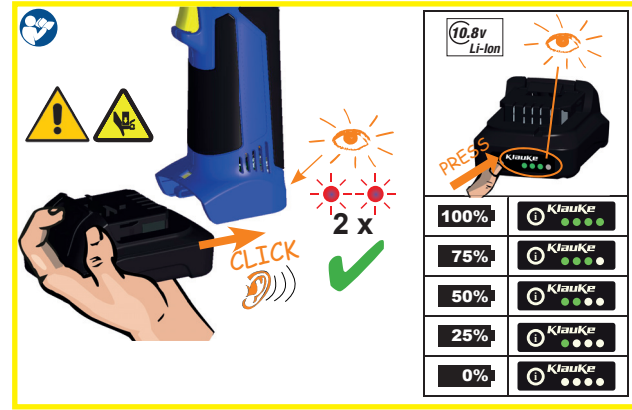
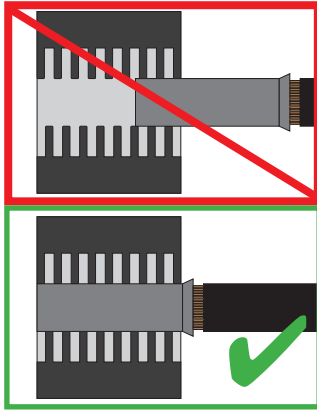



EKWF120ML

Klauke

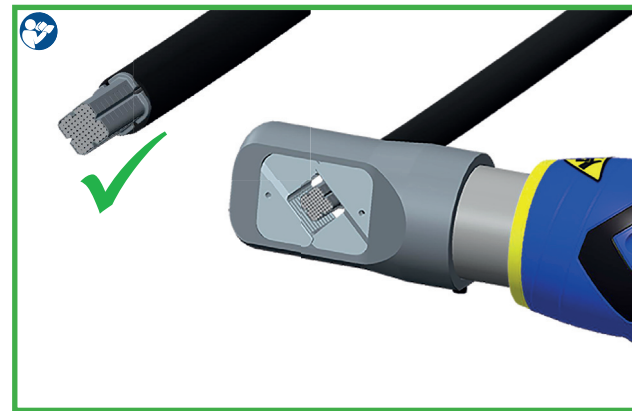
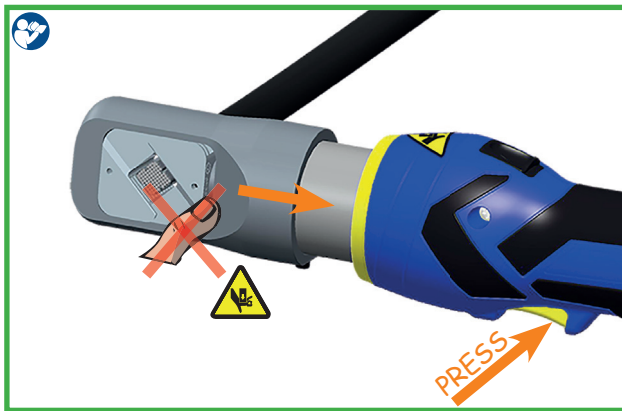
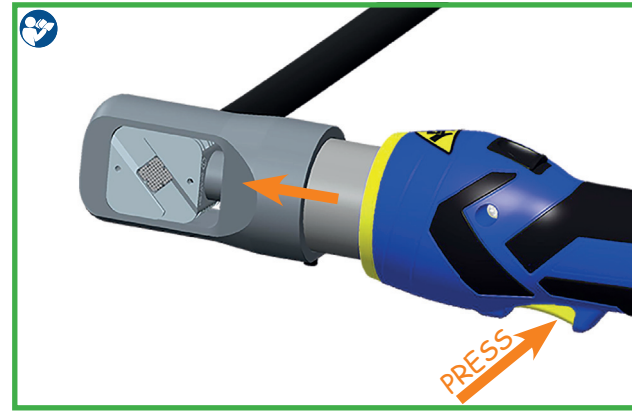
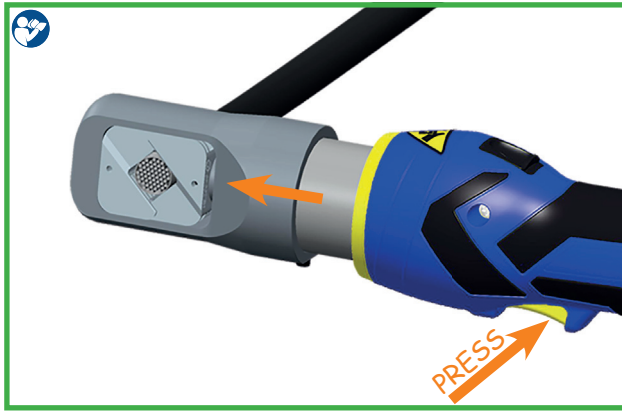



EKWF120ML

Klauke®

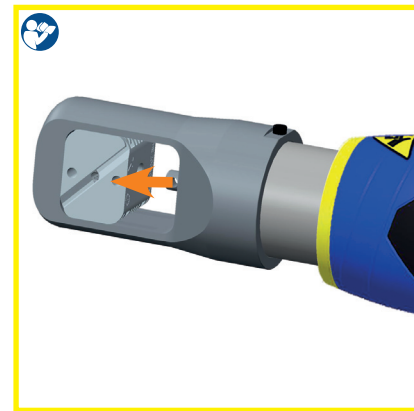
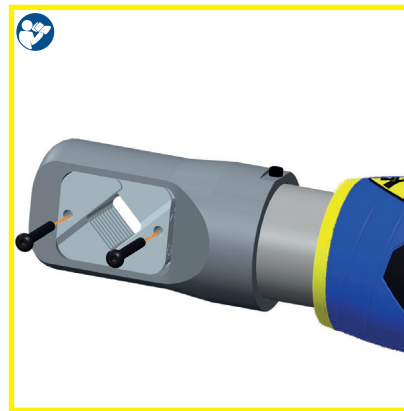
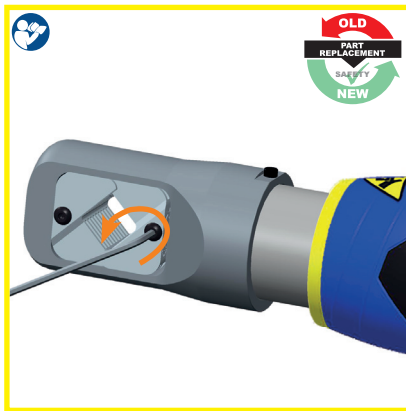
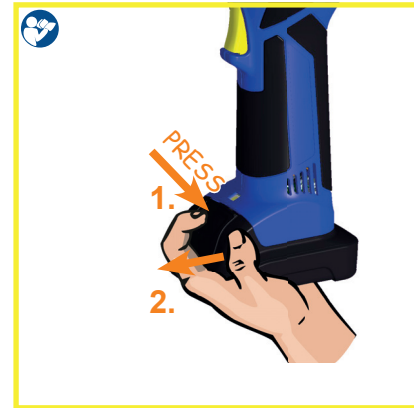
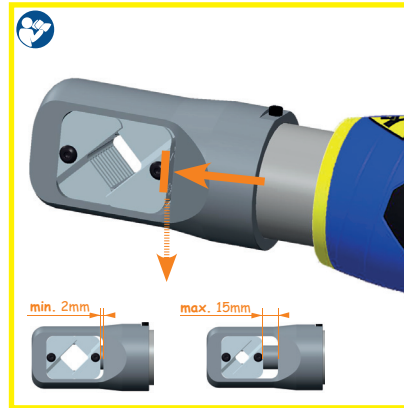
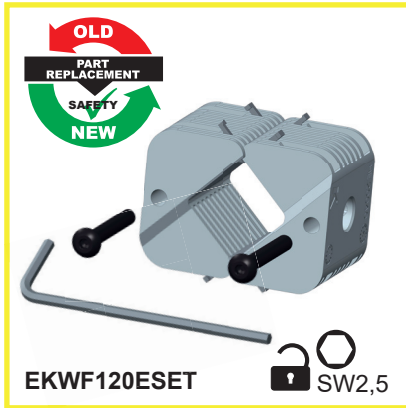



EKWF120ML

Klauke

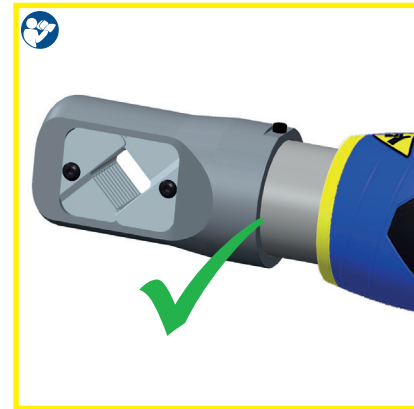
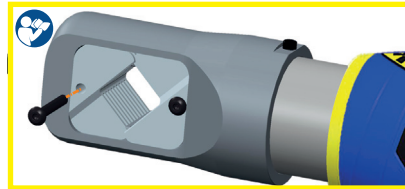
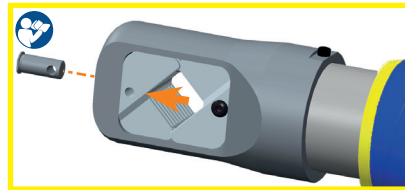
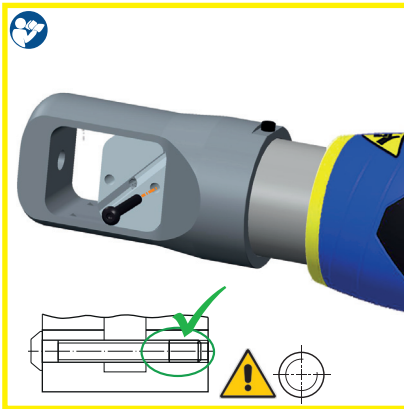
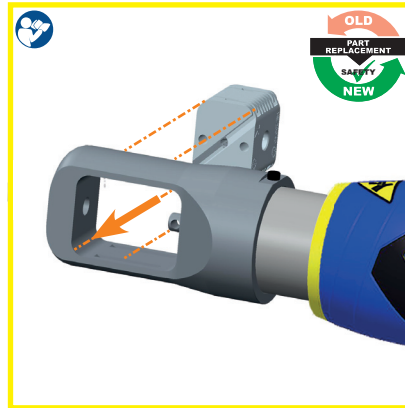
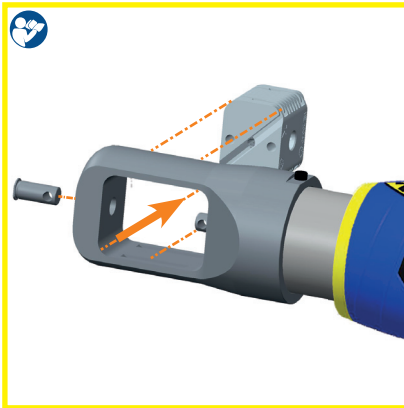



EKWF120ML

Klauke

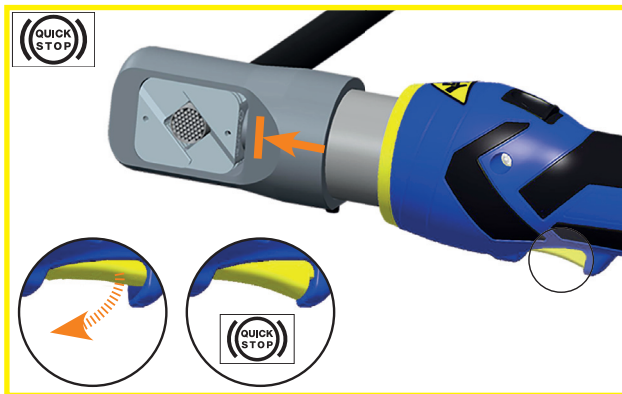
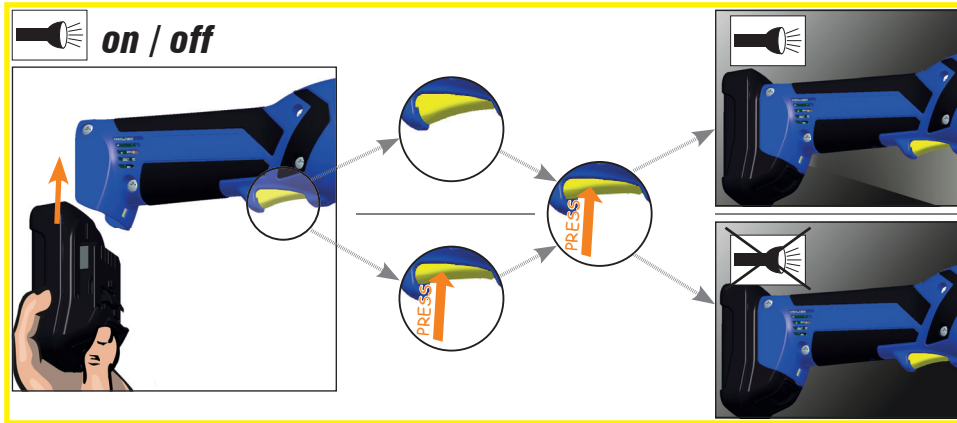



EKWF120ML

Klauke

BEFORE WORK

DIN EN 50110

2 years
Warranty
World wide
Tool
Service

-
-
-
-

once a year

Recommendation
Empfehlung

Klauke ASC
Authorized Service Center

3 years or
10.000 operations

OLD
PART
REPLACEMENT
SAFETY
NEW

2 years
Warranty
World wide
Tool
Service

Klauke ASC
Authorized Service Center

Klauke

WEEE
2012/19/EU

klauke-weee-abholung@emerson.com

Klauke ASC
Authorized Service Center

WORK



SERVICE















DON'T DO



General safety rules
HE.16048





	Wann/When/Quand/Quando/cuándo/Wanneer/Когда это происходит/Kiedy	Warum/Why/Pourquoi/Porquê/¿por qué?/Waarom/Причина/Dlaczego
 20 sec	nach Arbeitsvorgang/after working cycle après opération de travail Después del proceso de trabajo após o processo de trabalho na bedrijfscyclus после цикла опрессовки po zakończeniu pracy	
 2 x	nach Einsetzen des Akkus/after inserting the battery après mise en place de l'accumulateur Después de insertar la batería após inserir a bateria na het plaatsen van de accu при установке аккумулятора przy włożeniu akumulatora	Selbsttest/Self check autocontrôle Auto-test Autotest zelftest Проверка инструмента autotest
 20 sec/2Hz	nach Arbeitsvorgang/after working cycle après opération de travail Después del proceso de trabajo após o processo de trabalho na bedrijfscyclus после цикла опрессовки po zakończeniu pracy	 
 20 sec/5Hz	während der Übertemperatur/while exceeding the temp. limit pendant surchauffe en caso de temperatura excesiva durante a temperatura excessiva tijdens te hoge temperatuur при высокой температуре внутри корпуса w czasie nadmiernej temperatury	Werkzeug zu heiß/Unit too hot outil surchauffé Herramienta demasiado caliente ferramenta demasiado quente gereedschap te heet Перегрев инструмента narzędzie za gorące
 20 sec  20 sec/2Hz	nach Arbeitsvorgang/after working cycle après opération de travail Después del proceso de trabajo após o processo de trabalho na bedrijfscyclus после цикла опрессовки po zakończeniu pracy	  

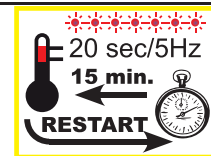

Handgeführtes batteriebetriebenes Elektrowerkzeug Typ EKWF120ML

Klauke

(D) CE-* - Konformitätserklärung. Wir erklären in alleiniger Verantwortlichkeit, daß dieses Produkt mit den folgenden Normen oder normativen Dokumenten übereinstimmt: EN 62841-1, EN ISO 12100, EN ISO 13857, EN ISO 13854, EN 28662-1, EN 61000-6-3, EN 61000-6-2, EN 60529, EN ISO 14118 gemäß den Bestimmungen der Richtlinien 2006/42/EG, 2014/30/EU, 2011/65/EU

(GB) CE-* - Declaration of conformity. We declare under our sole responsibility that this product is in conformity with the following standards or normative documents: EN 62841-1, EN ISO 12100, EN ISO 13857, EN ISO 13854, EN 28662-1, EN 61000-6-3, EN 61000-6-2, EN 60529, EN ISO 14118 in accordance with the regulations of directives 2006/42/EG, 2014/30/EU, 2011/65/EU

(F) CE-* - Déclaration de conformité. Nous déclarons sous notre seule responsabilité que ce produit est en conformité avec les normes ou documents normatifs suivants: EN 62841-1, EN ISO 12100, EN ISO 13857, EN ISO 13854, EN 28662-1, EN 61000-6-3, EN 61000-6-2, EN 60529, EN ISO 14118 conformément aux réglementations des directives 2006/42/EG, 2014/30/EU, 2011/65/EU

(E) CE-* - Declaración de conformidad. Declaramos bajo nuestra sola responsabilidad que este producto está en conformidad con las normas o documentos normativos siguientes: EN 62841-1, EN ISO 12100, EN ISO 13857, EN ISO 13854, EN 28662-1, EN 61000-6-3, EN 61000-6-2, EN 60529, EN ISO 14118 de acuerdo con las regulaciones de las directivas 2006/42/EG, 2014/30/EU, 2011/65/EU

(I) CE-* - Dichiarazione di conformità. Dichiariamo sotto la nostra esclusiva responsabilità che questo prodotto è conforme alle seguenti norme e documenti normativi: EN 62841-1, EN ISO 12100, EN ISO 13857, EN ISO 13854, EN 28662-1, EN 61000-6-3, EN 61000-6-2, EN 60529, EN ISO 14118 conformemente alle disposizioni delle direttive 2006/42/EG, 2014/30/EU, 2011/65/EU

(P) CE-* - Declaração de conformidade. Declaramos sob nossa exclusiva responsabilidade que este produto cumpre as seguintes normas ou documentos normativos: EN 62841-1, EN ISO 12100, EN ISO 13857, EN ISO 13854, EN 28662-1, EN 61000-6-3, EN 61000-6-2, EN 60529, EN ISO 14118 conforme as disposições das directivas 2006/42/EG, 2014/30/EU, 2011/65/EU

(NL) CE-* - Konformiteitsverklaring. Wij verklaren en wij stellen ons er alleen voor verantwoordelijk dat dit product voldoet aan de volgende normen of normatieve documenten: EN 62841-1, EN ISO 12100, EN ISO 13857, EN ISO 13854, EN 28662-1, EN 61000-6-3, EN 61000-6-2, EN 60529, EN ISO 14118 overeenkomstig de bepalingen van de richtlijnen 2006/42/EG, 2014/30/EU, 2011/65/EU

(GR) CE-* - ΔΗΛΩΣΗ ΣΥΜΜΟΡΦΩΣΗΣ Με αναληψη συνολικης δηλωνομε οτι το πορον προιον συμφωρει με τα παρακατω ποστυπα και με τα προτυπα ηου αναφερονται στα σχετικα εγγραφα EN 62841-1, EN ISO 12100, EN ISO 13857, EN ISO 13854, EN 28662-1, EN 61000-6-3, EN 61000-6-2, EN 60529, EN ISO 14118 συμφωνα με τοχς κοινοισμους 2006/42/EG, 2014/30/EU, 2011/65/EU

(S) CE-* - Konformitetsdeklaration. Vi förklarar på eget ansvar att denna produkt överensstämmer med följande normer eller normativa dokument: EN 62841-1, EN ISO 12100, EN ISO 13857, EN ISO 13854, EN 28662-1, EN 61000-6-3, EN 61000-6-2, EN 60529, EN ISO 14118 enligt bestämmelserna i direktiverna 2006/42/EG, 2014/30/EU, 2011/65/EU

(DK) CE-* - Konformitetserklæring. Vi erklærer under almindeligt ansvar at dette produkt er i overensstemmelse med følgende normer eller normative dokumenter: EN 62841-1, EN ISO 12100, EN ISO 13857, EN ISO 13854, EN 28662-1, EN 61000-6-3, EN 61000-6-2, EN 60529, EN ISO 14118 i henhold til bestemmelserne i direktiverne 2006/42/EØF, 2014/30/EU, 2011/65/EU

(N) CE-* - Konformitetserklæring. Vi erklærer på eget ansvar at dette produkt er i overensstemmelse med følgende standarder eller standard-dokumenter: EN 62841-1, EN ISO 12100, EN ISO 13857, EN ISO 13854, EN 28662-1, EN 61000-6-3, EN 61000-6-2, EN 60529, EN ISO 14118 i henhold til bestemmelserne i direktivene 2006/42/EØF, 2014/30/EU, 2011/65/EU

(FIN) CE-* - Todistus standardinmukaisuudesta. Asiaa vastaavana todistamme täten, että tämä tuote on seuraavien standardien ja standardoimisasiakirjojen vaatimusten mukainen: EN 62841-1, EN ISO 12100, EN ISO 13857, EN ISO 13854, EN 28662-1, EN 61000-6-3, EN 61000-6-2, EN 60529, EN ISO 14118 ja vastaa säädöksiä 2006/42/EG, 2014/30/EU, 2011/65/EU

(SK) CE-* - Prehlásenie o zhode. Prehlasujeme na vlastnú zodpovednosť, že tieto produkty sú v súlade s nasledovnými normami: EN 62841-1, EN ISO 12100, EN ISO 13857, EN ISO 13854, EN 28662-1, EN 61000-6-3, EN 61000-6-2, EN 60529, EN ISO 14118 a v zhode so smerniciami 2006/42/EG, 2014/30/EU, 2011/65/EU

(PL) CE-* - Zgodność z dyrektywami CE. Świadomi odpowiedzialności oświadczamy, że niniejszy produkt jest zgodny z następującymi normami lub dokumentacją normatywną: EN 62841-1, EN ISO 12100, EN ISO 13857, EN ISO 13854, EN 28662-1, EN 61000-6-3, EN 61000-6-2, EN 60529, EN ISO 14118 zgodnie z postanowieniami wytycznych 2006/42/EG, 2014/30/EU, 2011/65/EU

(CZ) CE-* - Prohlášení o shodě. Prohlasujeme na vlastní zodpovědnost, že tyto produkty splňují následující normy nebo normativní listiny: EN 62841-1, EN ISO 12100, EN ISO 13857, EN ISO 13854, EN 28662-1, EN 61000-6-3, EN 61000-6-2, EN 60529, EN ISO 14118; Ve shodě se směrnicemi 2006/42/EG, 2014/30/EU, 2011/65/EU

(SLO) CE-* - Izjava o skladnosti. S tem potrjujemo splošno odgovornost, da je ta izdelek narejen v skladu z navedenimi normami in standardi: EN 62841-1, EN ISO 12100, EN ISO 13857, EN ISO 13854, EN 28662-1, EN 61000-6-3, EN 61000-6-2, EN 60529, EN ISO 14118 ter določbami in smernicami 2006/42/EG, 2014/30/EU, 2011/65/EU

(HR) CE-* - Izjava o sukladnosti. Pod punom odgovornošću izjavljujemo da je proizvod naveden u naslovu ovog dokumenta sukladan sa primijenjenim normama i normativnim dokumentima : EN 62841-1, EN ISO 12100, EN ISO 13857, EN ISO 13854, EN 28662-1, EN 61000-6-3, EN 61000-6-2, EN 60529, EN ISO 14118 u skladu sa odredbama preporuka 2006/42/EG, 2014/30/EU, 2011/65/EU

(H) CE-* - Megfelelősségi nyilatkozat. Kéziműködtetésű elektromos kéziszerszámok: Teljes felelősséggel kijelentjük, hogy ezek a termékek a következő szabványokkal és irányelvekkel összhangban vannak: EN 62841-1, EN ISO 12100, EN ISO 13857, EN ISO 13854, EN 28662-1, EN 61000-6-3, EN 61000-6-2, EN 60529, EN ISO 14118; és megfelelnek a rendeltetés szerinti 2006/42/EG, 2014/30/EU, 2011/65/EU irányelveknek.

(RO) CE-* - Declarație de conformitate. Noi declarăm pe propria răspundere că acest produs este în conformitate cu următoarele norme și documente normative: EN 62841-1, EN ISO 12100, EN ISO 13857, EN ISO 13854, EN 28662-1, EN 61000-6-3, EN 61000-6-2, EN 60529, EN ISO 14118; potrivit dispozițiilor directivelor 2006/42/EG, 2014/30/EU, 2011/65/EU

Remscheid, 22.02.2022



Joh. - Christoph Schütz

Dipl.-Ing. Joh.-Christoph Schütz, CE-Representative

*2021

Handgeführtes batteriebetriebenes Elektrowerkzeug Typ EKWF120ML

Klauke

(D) UKCA-^{*} - Konformitätserklärung. Wir erklären in alleiniger Verantwortlichkeit, dass dieses Produkt mit den folgenden Normen oder normativen Dokumenten übereinstimmt: BS EN 62841-1, BS EN ISO 12100, BS EN ISO 13857, BS EN ISO 13854, BS EN 28662-1, BS EN 61000-6-3, BS EN 61000-6-2, BS EN ISO 14118 gemäß den Bestimmungen der Richtlinien 2006/42/EG, 2014/30/EU, 2011/65/EU

(GB) UKCA-^{*} - Declaration of conformity. We declare under our sole responsibility that this product is in conformity with the following standards or normative documents: BS EN 62841-1, BS EN ISO 12100, BS EN ISO 13857, BS EN ISO 13854, BS EN 28662-1, BS EN 61000-6-3, BS EN 61000-6-2, BS EN ISO 14118 in accordance with the regulations of directives 2006/42/EG, 2014/30/EU, 2011/65/EU

(F) UKCA-^{*} - Déclaration de conformité. Nous déclarons sous notre seule responsabilité que ce produit est en conformité avec les normes ou documents normatifs suivants: BS EN 62841-1, BS EN ISO 12100, BS EN ISO 13857, BS EN ISO 13854, BS EN 28662-1, BS EN 61000-6-3, BS EN 61000-6-2, BS EN ISO 14118 conformément aux réglementations des directives 2006/42/EG, 2014/30/EU, 2011/65/EU

(E) UKCA-^{*} - Declaración de conformidad. Declaramos bajo nuestra sola responsabilidad que este producto está en conformidad con las normas o documentos normativos siguientes: BS EN 62841-1, BS EN ISO 12100, BS EN ISO 13857, BS EN ISO 13854, BS EN 28662-1, BS EN 61000-6-3, BS EN 61000-6-2, BS EN ISO 14118 de acuerdo con las regulaciones de las directivas 2006/42/EG, 2014/30/EU, 2011/65/EU

(I) UKCA-^{*} - Dichiarazione di conformità. Dichiariamo sotto la nostra esclusiva responsabilità che questo prodotto è conforme alle seguenti norme e documenti normativi: BS EN 62841-1, BS EN ISO 12100, BS EN ISO 13857, BS EN ISO 13854, BS EN 28662-1, BS EN 61000-6-3, BS EN 61000-6-2, BS EN ISO 14118 conformemente alle disposizioni delle direttive 2006/42/EG, 2014/30/EU, 2011/65/EU

(P) UKCA-^{*} - Declaração de conformidade. Declaramos sob nossa exclusiva responsabilidade que este produto cumpre as seguintes normas ou documentos normativos: BS EN 62841-1, BS EN ISO 12100, BS EN ISO 13857, BS EN ISO 13854, BS EN 28662-1, BS EN 61000-6-3, BS EN 61000-6-2, BS EN ISO 14118 conforme as disposições das directivas 2006/42/EG, 2014/30/EU, 2011/65/EU

(NL) UKCA-^{*} - Konformiteitsverklaring. Wij verklaren en wij stellen ons er alleen voor verantwoordelijk dat dit product voldoet aan de volgende normen of normatieve documenten: BS EN 62841-1, BS EN ISO 12100, BS EN ISO 13857, BS EN ISO 13854, BS EN 28662-1, BS EN 61000-6-3, BS EN 61000-6-2, BS EN ISO 14118 overeenkomstig de bepalingen van de richtlijnen 2006/42/EG, 2014/30/EU, 2011/65/EU

(GR) UKCA-^{*} - ΔΗΛΩΣΗ ΣΥΜΜΟΡΦΩΣΗΣ Μ-ε αναλήψη συλλογικής δήλωσμε- οτι το πορον προιον συμφωνα με τα παρακατω ποστηπα και με τα προτηρα που αναφερονται στα σχετικα εργαααα BS EN 62841-1, BS EN ISO 12100, BS EN ISO 13857, BS EN ISO 13854, BS EN 28662-1, BS EN 61000-6-3, BS EN 61000-6-2, BS EN ISO 14118 συμφωνα με τοα κοινοτομοα 2006/42/EG, 2014/30/EU, 2011/65/EU

(S) UKCA-^{*} - Konformitetsdeklaration. Vi förklarar på eget ansvar att denna produkt överensstämmer med följande normer eller normativa dokument: BS EN 62841-1, BS EN ISO 12100, BS EN ISO 13857, BS EN ISO 13854, BS EN 28662-1, BS EN 61000-6-3, BS EN 61000-6-2, BS EN ISO 14118 enligt bestämmelserna i direktiverna 2006/42/EG, 2014/30/EU, 2011/65/EU

(DK) UKCA-^{*} - Konformitetserklæring. Vi erklærer under almindeligt ansvar at dette produkt er i overensstemmelse med følgende normer eller normative dokumenter: BS EN 62841-1, BS EN ISO 12100, BS EN ISO 13857, BS EN ISO 13854, BS EN 28662-1, BS EN 61000-6-3, BS EN 61000-6-2, BS EN ISO 14118 i henhold til bestemmelserne i direktivene 2006/42/EØF, 2014/30/EU, 2011/65/EU

(N) UKCA-^{*} - Konformitetserklæring. Vi erklærer på eget ansvar at dette produkt er i overensstemmelse med følgende standarder eller standard-dokumenter: BS EN 62841-1, BS EN ISO 12100, BS EN ISO 13857, BS EN ISO 13854, BS EN 28662-1, BS EN 61000-6-3, BS EN 61000-6-2, BS EN ISO 14118 i henhold til bestemmelserne i direktive ne 2006/42/EØF, 2014/30/EU, 2011/65/EU

(FIN) UKCA-^{*} - Todistus standardin mukaisuudesta. Asiasta vastaavana todistamme täten, että tämä tuote on seuraavien standardien ja standardoimisasiakirjojen vaatimusten mukainen: BS EN 62841-1, BS EN ISO 12100, BS EN ISO 13857, BS EN ISO 13854, BS EN 28662-1, BS EN 61000-6-3, BS EN 61000-6-2, BS EN ISO 14118 ja vastaa säädöksiä 2006/42/EG, 2014/30/EU, 2011/65/EU

(SK) UKCA-^{*} - Prehlásenie o zhode. Prehlasujeme na vlastnú zodpovednosť, že tieto produkty sú v súlade s nasledovnými normami: BS EN 62841-1, BS EN ISO 12100, BS EN ISO 13857, BS EN ISO 13854, BS EN 28662-1, BS EN 61000-6-3, BS EN 61000-6-2, BS EN ISO 14118 a v zhode so smerniciami 2006/42/EG, 2014/30/EU, 2011/65/EU

(PL) UKCA-^{*} - Zgodność z dyrektywami UKCA. Świadomi odpowiedzialności oświadczamy, że niniejszy produkt jest zgodny z następującymi normami lub dokumentacją normatywna: BS EN 62841-1, BS EN ISO 12100, BS EN ISO 13857, BS EN ISO 13854, BS EN 28662-1, BS EN 61000-6-3, BS EN 61000-6-2, BS EN ISO 14118 zgodnie z postanowieniami wytycznych 2006/42/EG, 2014/30/EU, 2011/65/EU

(CZ) UKCA-^{*} - Prohlášení o shode. Prohlasujeme na vlastní zodpovednosť, že tyto produkty splňují následující normy nebo normativní listiny: BS EN 62841-1, BS EN ISO 12100, BS EN ISO 13857, BS EN ISO 13854, BS EN 28662-1, BS EN 61000-6-3, BS EN 61000-6-2, BS EN ISO 14118; Ve shode se směrnicemi 2006/42/EG, 2014/30/EU, 2011/65/EU

(SLO) UKCA-^{*} - Izjava o skladnosti. S tem potrjujemo splošno odgovornost, da je ta izdelek narejen v skladu z navedenimi normami in standardi: BS EN 62841-1, BS EN ISO 12100, BS EN ISO 13857, BS EN ISO 13854, BS EN 28662-1, BS EN 61000-6-3, BS EN 61000-6-2, BS EN ISO 14118 ter dolocbami in smernicami 2006/42/EG, 2014/30/EU, 2011/65/EU

(HR) UKCA-^{*} - Izjava o skladnosti. Pod punom odgovornošću izjavljujemo da je proizvod naveden u naslovu ovog dokumenta sukladan sa primijenjenim normama i normativnim dokumentima: BS EN 62841-1, BS EN ISO 12100, BS EN ISO 13857, BS EN ISO 13854, BS EN 28662-1, BS EN 61000-6-3, BS EN 61000-6-2, BS EN ISO 14118 u skladu sa odredbama preporuka 2006/42/EG, 2014/30/EU, 2011/65/EU

(H) UKCA-^{*} - Megfelelőségi nyilatkozat. Kéziműködtetésű elektromos kéziszerszámok: Teljes felelősséggel kijelentjük, hogy ezek a termékek a következő szabványokkal és irányelvekkel összhangban vannak: BS EN 62841-1, BS EN ISO 12100, BS EN ISO 13857, BS EN ISO 13854, BS EN 28662-1, BS EN 61000-6-3, BS EN 61000-6-2, BS EN ISO 14118; és megfelelnek a rendelkezés szerinti 2006/42/EG, 2014/30/EU, 2011/65/EU irányelveknek.

(RO) UKCA-^{*} - Declarație de conformitate. Noi declarăm pe propria răspundere că acest produs este în conformitate cu următoarele norme și documente normative: BS EN 62841-1, BS EN ISO 12100, BS EN ISO 13857, BS EN ISO 13854, BS EN 28662-1, BS EN 61000-6-3, BS EN 61000-6-2, BS EN ISO 14118; potrivit dispozițiilor directivelor 2006/42/EG, 2014/30/EU, 2011/65/EU

Remscheid, 22.02.2022

**UK
CA** Klauke UK Ltd.
NR35 1JX

Joh. - Christoph Schütz

Dipl.-Ing. Joh.-Christoph Schütz, CE-Representative

*2021