



[www.klauke.com](http://www.klauke.com)

# EK 135FTCFB



Serialnumber

HE.17253\_E © 05/2016 R&D-2



Gustav Klauke GmbH • Auf dem Knapp 46 • D-42855 Remscheid • Telefon +49 2191 907 0 • [www.klauke.com](http://www.klauke.com)

# Klauke



Wir freuen uns, dass Sie sich für ein Klauke Werkzeug entschieden haben und wünschen Ihnen viel Freude damit.



Sie haben ein Qualitätsprodukt „Made in Germany“ erworben und erhalten 2 Jahre Garantie. Diese beginnt mit dem Kaufbelegdatum.

Um lange Freude und eine einwandfreie Funktion des Werkzeuges sicherzustellen, muss das Gerät spätestens beim Erreichen von 10.000 Arbeitsvorgängen oder nach 3 Jahren durch ein Autorisiertes Service Center (ASC) gewartet werden. Wird das Wartungsintervall von 10.000 Arbeitsvorgängen nicht eingehalten, erlischt der Garantieanspruch.

Im Rahmen dieser Wartung werden verschlissene Teile ersetzt und sicherheitsrelevante Teile geprüft und ggf. vorbeugend ersetzt.

Darüber hinaus empfehlen wir das Gerät jährlich zur Überprüfung an das zuständige ASC einzusenden.

Für Fragen rund um unseren Werkzeugservice stehen wir Ihnen unter folgenden Rufnummern persönlich zur Verfügung:

Technik +492332709544

Reparaturen / Leihgeräte +492332709540



Ihr Klauke-Service Team



Die Bluetooth®-Wortmarke und das Bluetooth®-Symbol sind eingetragene Warenzeichen der Bluetooth SIG, Inc. und jegliche Verwendung durch Gustav Klauke GmbH ist lizenziert.

Thank you for choosing a Klauke tool. We hope it gives you lots of pleasure.

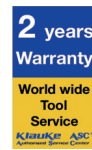

You have purchased a quality product „Made in Germany“, which is covered by a 2 year warranty. The warranty commences from the purchase receipt date.

To ensure lasting enjoyment and a flawless tool function, the product must be serviced by an AuthorisedServiceCenter(ASC)after10,000operations or after 3 years. Should the service Interval exceed 10.000 cycles the warranty claim is void.

The Service includes predictive maintenance in which worn-out parts will be replaced and safety relevant parts checked/replaced.

We recommend to have the tools checked yearly through an Authorized Service Center (ASC).

For questions about our tool service we are personally available under the following telephone numbers:

Technical Support +492332709544

Repairs / Loaner tools +492332709540



Your Klauke-Service Team



The Bluetooth® word mark and Bluetooth® symbol are registered trademarks of Bluetooth SIG, Inc. and any use by Gustav Klauke GmbH is licensed.

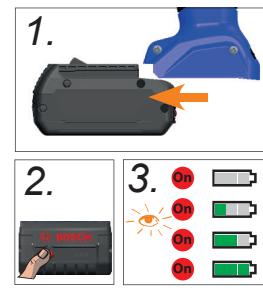

**⚠ WARNING**

Read all safety warnings, instructions, illustrations and specifications provided with this power tool. Failure to follow all instructions listed below may result in electric shock, fire and/or serious injury. Save all warnings and instructions for future reference.

datecode

| Year | Code | Month | Code | Month | Code |
|------|------|-------|------|-------|------|
| 2022 | R    | Jan.  | N    | July  | V    |
| 2023 | S    | Feb.  | P    | Aug.  | W    |
| 2024 | T    | Mar.  | Q    | Sept. | X    |
| 2025 | V    | Apr.  | R    | Oct.  | Y    |
| 2026 | W    | May   | S    | Nov.  | Z    |
| 2027 | X    | June  | T    | Dec.  | 1    |

batch# e.g. 304711  
 datecode e.g. X = 2027; R = April  
 consecutive# e.g. „142“ = tool # 142



304711  
XR  
142

**Klauke**  
 Auf dem Knapp 46  
 D-42855  
 Remscheid

**2 years Warranty**  
 World wide Tool Service

**ACHTUNG!** Bei Beschädigung Garantieverlust  
**ATTENTION!** Warranty seal if broken loses of Warranty

**Garantiesiegel** / **Warranty seal**



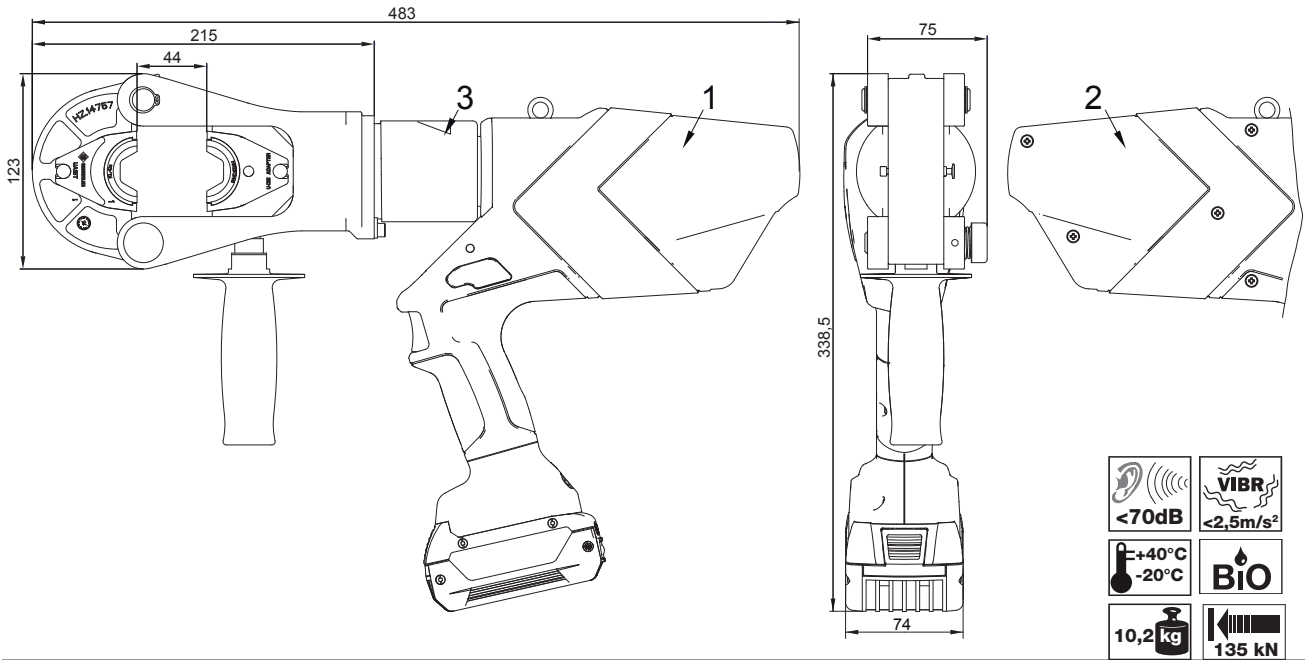

Use tool only with 18 V Bosch battery

**BOSCH**  
#1 609 92A 19R  
#1 609 92A 0F3

Li-ion

Loading Full

**BOSCH 18V 5,0Ah Li-Ion**

| Ladegerät   | GAL                            | GAL 1880 CV                    |
|---|--------------------------------|--------------------------------|
| Sachnummer  | 2 607 225 ...<br>2 607 226 ... | 2 607 225 9..<br>2 607 226 0.. |
| Akku-Ladespannung (automatische Spannungserkennung) V <sub>DC</sub> | 14,4–36                        | 14,4–18                        |
| Ladestrom A   | 8,0                            | 8,0                            |
| Zulässiger Ladetemperaturbereich °C                                 | 0–45                           | 0–45                           |
| Ladezeit bei Akku-Kapazität, ca.                                    | (80%) 100%                     | (80%) 100%                     |
| - 1,3 Ah  | min (10) 25                    | (10) 25                        |
| - 1,5 Ah  | min (10) 25                    | (10) 25                        |
| - 2,0 Ah RALB1__ (36Wh)   | min (15) 30                    | (15) 30                        |
| - 2,6 Ah  | min (15) 30                    | (15) 30                        |
| - 3,0 Ah  | min (20) 35                    | (20) 35                        |
| - 4,0 Ah  | min (25) 35                    | (25) 35                        |
| - 5,0 Ah RALB2__ (90Wh)   | min (35) 45                    | (35) 45                        |
| - 6,0 Ah  | min (35) 50                    | (35) 50                        |
| Anzahl der Akkuzellen   | 4–30                           | 4–10                           |
| Gewicht entsprechend EPTA-Procedure 01:2014                         | kg 0,9                         | 0,7                            |
| Schutzklasse  | □ / II                         | □ / II                         |

1.

2.

3.

Alle Bedienungsanleitungen auch unter [www.klauke.de](http://www.klauke.de) abrufbar  
All manuals are also available on [www.Klauke.com](http://www.Klauke.com)

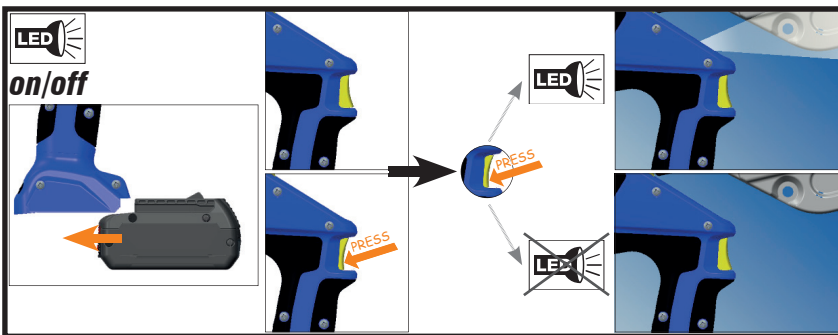
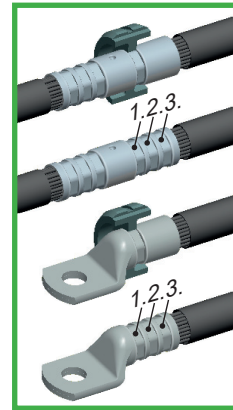
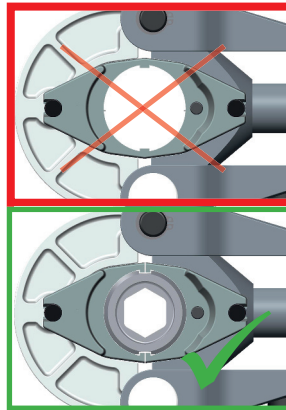

| Artikel-Nr.<br>Part No. |  | Erläuterung<br>Explanation  | Pressbereich<br>Crimping range |
|-------------------------|--|---|--------------------------------|
| UA15T                   |  | Adapter für die 13er Einsatzserie<br>Adapter for the 13 series dies | <b>K13</b><br>SERIE            |
| HL15500                 |  | Einsatz für Kupfer Kabelschuhe<br>Die for copper cable lug up       | 500 mm <sup>2</sup>            |
| HL15630                 |  | Einsatz für Kupfer Kabelschuhe<br>Die for copper cable lug up       | 630 mm <sup>2</sup>            |
| HA15500                 |  | Einsatz für Aluminium Kabelschuhe<br>Die for aluminium cable lugs   | 500 mm <sup>2</sup>            |
| HA13400                 |  |   | 400 mm <sup>2</sup>            |
| HA13300                 |  |   | 300 mm <sup>2</sup>            |



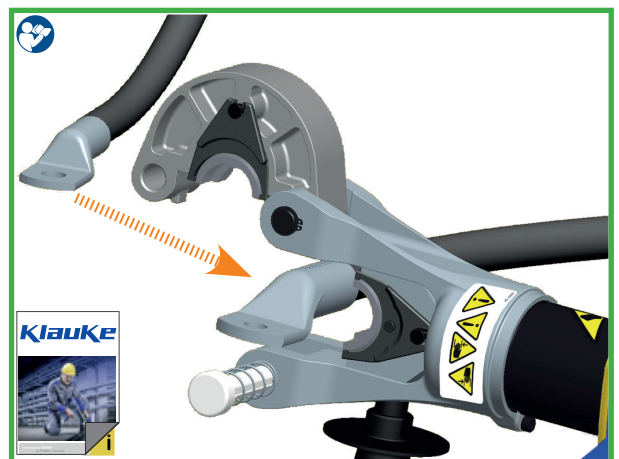
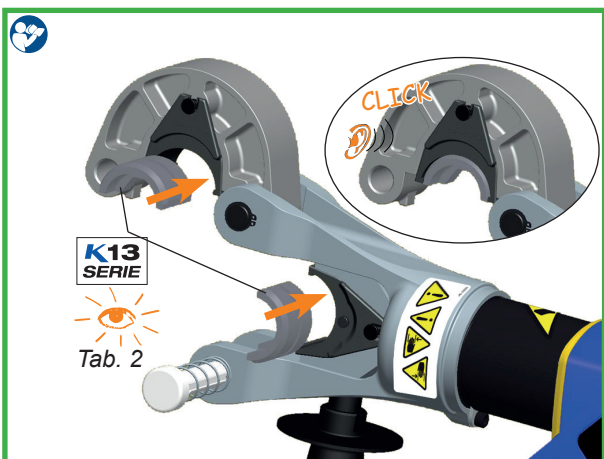
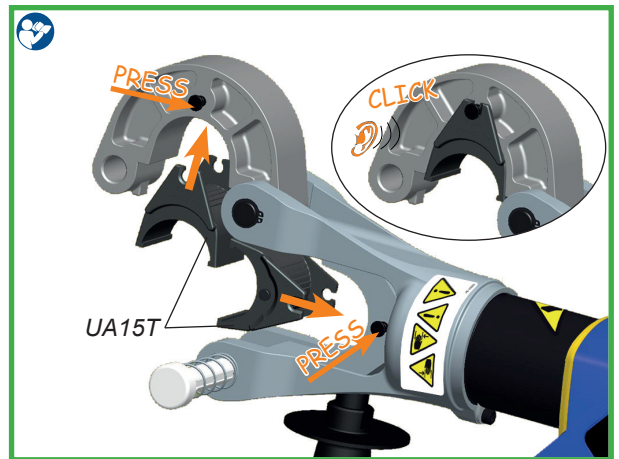
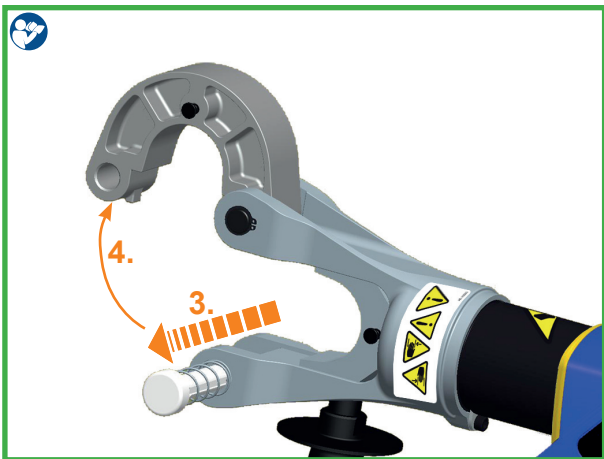
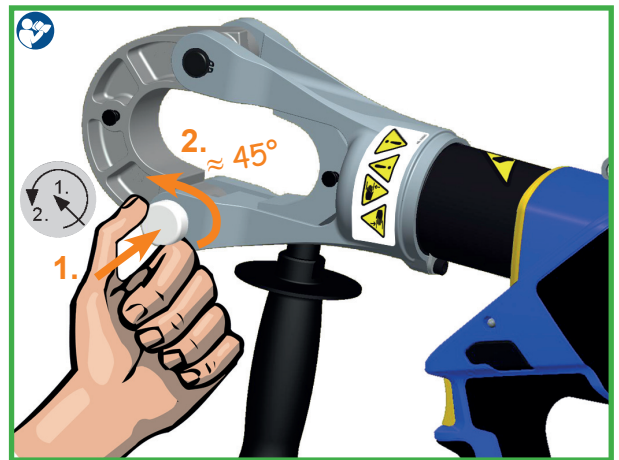
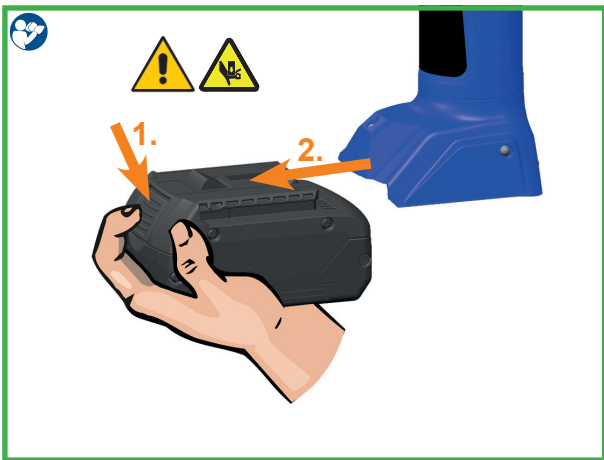
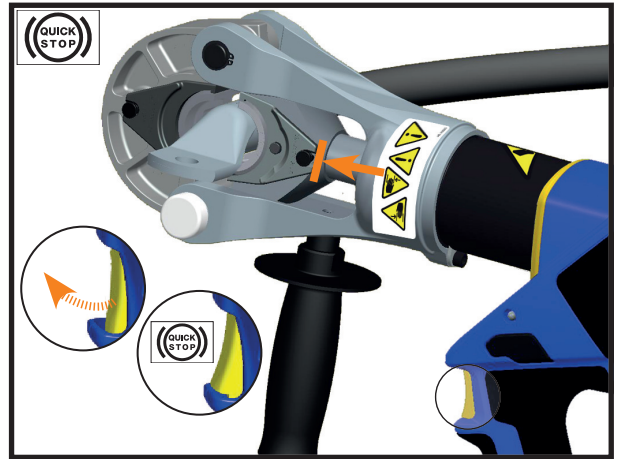

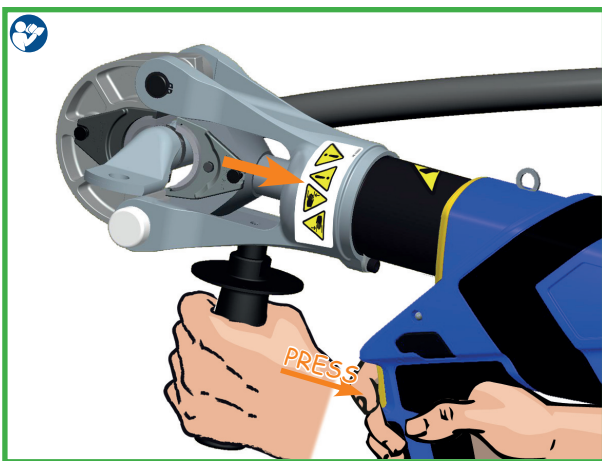
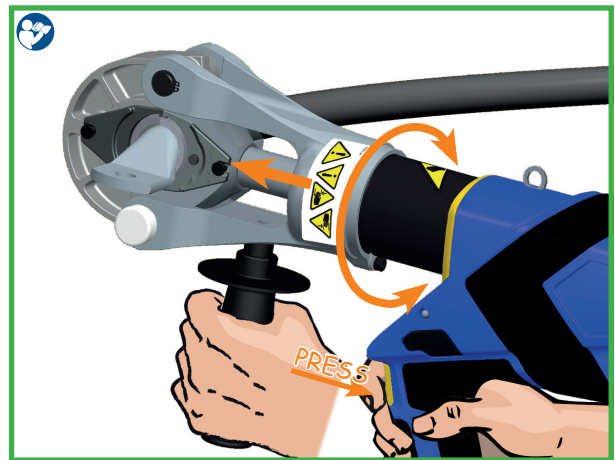



**BEFORE WORK**

DIN EN 50110

- 1.
- 2.
- 3.



once a year

Recommendation • Empfehlung

**Klauke ASC**  
Authorized Service Center

3 years or 10.000 operations

2 years Warranty  
World wide Tool Service

**Klauke ASC**  
Authorized Service Center

WEEE 2012/19/EU

Klauke-WEEE-Abholung@Emerson.com

**Klauke ASC**  
Authorized Service Center

**Klauke**® Crimp Chart EK120xxx tool series\*2

Hex crimps

| Klauke R-series<br>Copper connector type          | Ring type          | Angle type 90°        | Angle type 45°        |
|---|--------------------|-----------------------|-----------------------|
| Copper lugs R-series<br>(Class 2 & 5)             | 3Rxx - 12Rxx       | 43Rxx - 52Rxx         | 43Rxx45 - 52Rxx45     |
| Copper slices R-series<br>(Class 2 & 5)           |                    |                       |                       |
| T-splices R-series<br>(Class 2 & 5)               |                    |                       |                       |
| Cross-Splices<br>(Class 2 & 5)                    |                    |                       |                       |
| Lugs for switch gear<br>connections (Class 2 & 5) | 5SGxx - 12SGxx     |                       |                       |
| Klauke L-series<br>Copper connector type          | Ring type          | Angle type 90°        | Angle type 45°        |
| Copper lugs L-series<br>(Class 2, 5 & 6)          | L16xxxx - L240xxxx | L16890xx - L240890xxx | L16845xx - L240845xxx |
| Copper slices L-series<br>(Class 2, 5 & 6)        |                    |                       |                       |
| Klauke NDC-series<br>Copper connector type        | Ring type          | Fork type             | Pin type              |
| Copper lugs NDC-series<br>(Class 2 & 5)           | NDC16-300          |                       |                       |

Number of crimps\*1: 16 mm<sup>2</sup> - 185 mm<sup>2</sup> = 1 crimp / 240 mm<sup>2</sup> - 300 mm<sup>2</sup> = 2 crimps

\*1 see chart in main catalog

\*2 EK120/30L, EK120/30LINS, EK120/42L, EK120/42LINS, EK120UNVL, HK120/30INS, HK120/42INS, EK12030L, EK12042L, EK120UL, EK12030CFM, EK12030CFB, EK12042CFM, EK12042CFB, EK12030CFMINS, EK12030CFBINS, EK12042CFMINS, EK12042CFBINS, EK120UCFM, EK120UCFB, HK12030, HK12042, HK120U, PK12030, PK12042, EK135FTL, EK135FTCFM, EK135FTCFB, PK135FT, EK135L, EK135CFM, EK135CFB, PK135FT, EK120UNVCFM, EK120UNVCFB, HK120UNV, PK120UNV



HE:10890\_D





|    |            |   |  |
|----|------------|---|--|
| 1  |            |   |  |
| 2  |            | <b>Klauke</b>                                   |  |
|    |            | ERROR CODE:<br>****                             | Error code *1  |
| 3  |            | BT<br>P 3 bar<br>P 3 bar                        | Bluetooth (if connected)<br>Battery charging level<br>Current pressure<br>Pressure max. *2             |
| 4a |            | USER 3:<br>RDE Doppelklick                      | DoubleClick  |
| 4b | <br>3 sec. | USER SELECT 3:<br>RDE Einfachklick              | Singleclick<br>enter menu  |
| 4c |            | USER SELECT+:<br>RDE Doppelklick                | DoubleClick<br>select  |
| 4d |            | USER SELECT:<br>RDE Doppelklick                 | DoubleClick<br>confirmed   |
|    |            |   | additional profiles:<br>ARS Single Click<br>ARS Double Click<br>MRS+ Single Click<br>MRS+ Double Click |
| 5  |            | NEXT SERVICE:<br>9826 0 P s                     | Cycles<br>(until next service)   |
| 6  |            | TOTAL:<br>t = 0.07 h<br>Q = 21.12 Ah<br>n = 174 | Since manufacturing:<br>operating hours<br>Capacity<br># crimps  |
| 7  |            | <b>RETURN</b>                                   |  |

\*1 Error codes/ Fehlermeldungen:

- Overcurrent fuse
- Overcurrent comparator
- Overheat board
- Overheat battery
- Battery empty, operation stop
- Faulty crimp motor in operation
- Faulty crimp motor not in operation
- Low battery
- Battery empty
- RTC battery low
- Service necessary
- RTC not found
- BT unit not found
- Mobile unit not found
- Pressure sensor not found
- Burst pressure exceeded
- Battery temperature too low
- Battery reserves
- Overcurrent fuse (I)
- Remote Control Battery Low\*
- Service necessary SAST1
- Service necessary SAST2
- Service necessary SAST3
- Remote mode: tool trigger not actuated\*
- Overheat motor
- Service necessary: Pressure low
- Service necessary: Pressure high

1 Überstromsicherung  
2 Überstromsicherung durch Komparator  
3 Boardtemperatur zu hoch  
4 Akkuteperatur zu hoch  
5 Akkuspannung zu gering  
6 Fehlpressung bei laufendem Motor  
7 Fehlpressung bei stehendem Motor  
8 Niedrige Akkuspannung  
9 Akku leer  
10 RTC-Batterie leer  
12 Service nötig  
13 RTC nicht verfügbar  
14 BT-Modul nicht verfügbar  
15 Modul nicht verfügbar  
16 Drucksensor nicht verfügbar  
17 Berstdruck überschritten  
18 Akkuteperatur zu gering  
19 Batteriereserven zu gering  
20 Überstromsicherung (I)  
21 Fernbedienung-Batterie schwach\*  
22 Service notwendig SAST1  
23 Service notwendig SAST2  
24 Service notwendig SAST3  
25 Remote-Modus: WZ-Taster nicht betätigt\*  
27 Motortemperatur zu hoch  
28 Service notwendig: Druck niedrig  
29 Service notwendig: Druck hoch  
\* remote control tools only /  
nur bei fernbedienungsfähigen Werkzeugen

\*2 (2Hz)

**Klauke i-press® Software**  
[www.klauke.com/connectivity](http://www.klauke.com/connectivity)

**Klauke i-press® App**

Download on the App Store

ANDROID APP ON Google play

|  |           |        |   |
|--|-----------|--------|---|
|  |           |        |   |
|  | ≤ 20 sec. |        | ✓ |
|  | > 20 sec. |        |   |
|  |           | REPEAT | ✓ |



### Automatic Retraction Stop

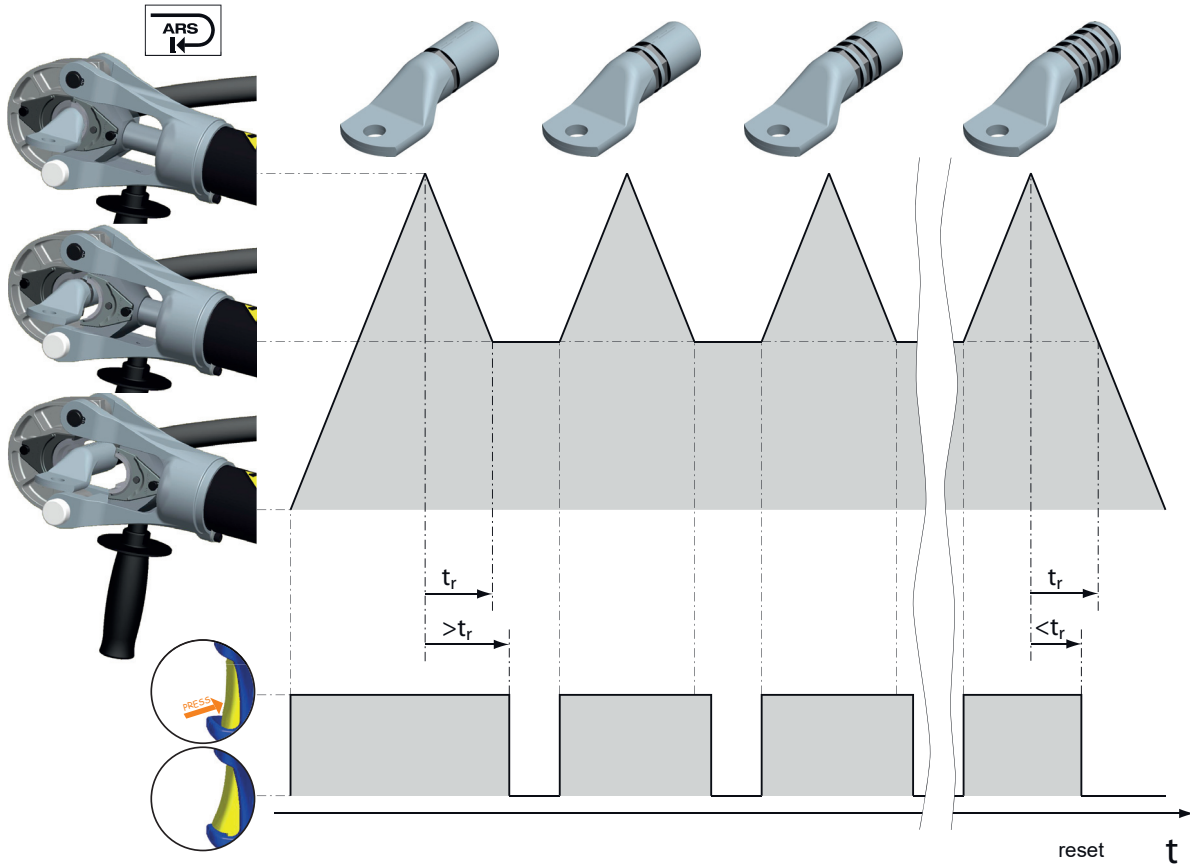

### Manual Retraction Stop +

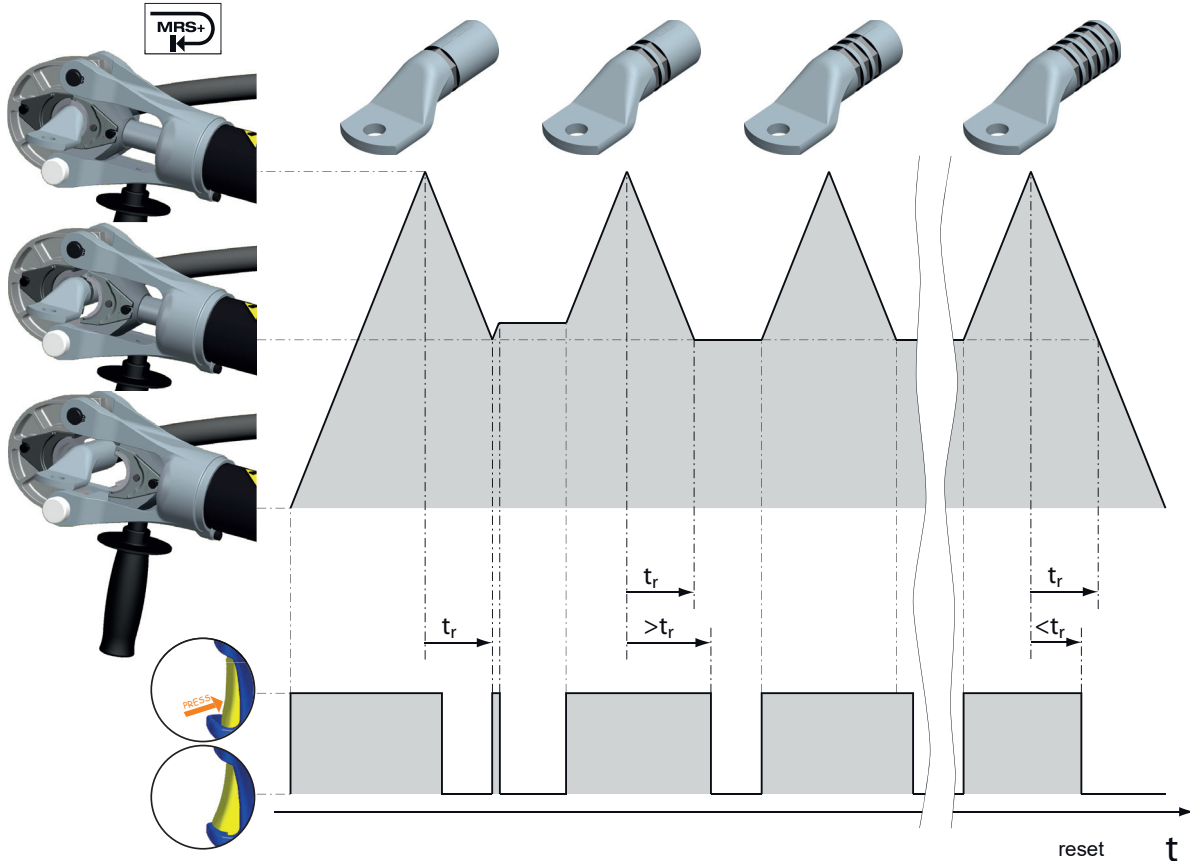



| SERVICE<br>    | LED<br> |  | Wann/When/Quand/Quando/<br>cuándo/Wanneer/Когда/это<br>происходит/Kiedy/quando  | Warum/Why/Pourquoi/Porquê/<br>¿por qué?/Waarom/Причина/<br>Dlaczego/Perché  |
|----------------|---------|--|---|---|
| <br>20 sec     |         |  | nach Arbeitsvorgang<br>after working cycle<br>après opération de travail<br>Después del proceso de trabajo<br>após o processo de trabalho<br>na bedrijfscyclus<br>после цикла опрессовки<br>po zakończeniu pracy<br>dopo il processo di lavoro  |   |
| <br>20 sec/2Hz |         |  | nach Arbeitsvorgang<br>after working cycle<br>après opération de travail<br>Después del proceso de trabajo<br>após o processo de trabalho<br>na bedrijfscyclus<br>после цикла опрессовки<br>po zakończeniu pracy<br>dopo il processo di lavoro  | <br><b>Klauke ASC</b><br>Authorized Service Center  |
| <br>20 sec/5Hz |         |  | während der Übertemperatur<br>while exceeding the temp. limit<br>pendant surchauffe<br>en caso de temperatura excesiva<br>durante a temperatura excessiva<br>tijdens te hoge temperatuur<br>при высокой температуре<br>внутри корпуса<br>przy przegrzaniu<br>superando il limite di temperatura | Werkzeug zu heiß<br>Unit too hot<br>outil surchauffé<br>Herramienta demasiado caliente<br>ferramenta demasiado quente<br>gereedschap te heet<br>Перегрев инструмента<br>urządzenie za gorące<br>Utensile troppo caldo<br>   |
| <br>1 x        | <br>1 x |  | nach Arbeitsvorgang<br>after working cycle<br>après opération de travail<br>Después del proceso de trabajo<br>após o processo de trabalho<br>na bedrijfscyclus<br>после цикла опрессовки<br>po zakończeniu pracy<br>dopo il processo di lavoro  | Fehler: der notwendige Pressdruck wurde nicht erreicht. Es handelt sich um eine manuelle Unterbrechung der Pressung bei stehendem Motor.<br>Error: the required pressure has not been reached. The operator has interrupted the pressing cycle manually while the motor was not running.<br>ERREUR: Pression nécessaire pas atteinte. Il s'agit d'une interruption manuelle de la sertissage au moteur arrêté.<br>Error: No se ha alcanzado la presión necesaria o el operador ha interrumpido el ciclo a mano mientras el motor ha parado.<br>Falha: a pressão de prensagem necessária não foi alcançada. Trata-se de uma interrupção manual da prensagem com o motor parado.<br>Foutmelding: De benodigde persdruk wordt niet bereikt. De gebruiker heeft de verkramping handmatig stopgezet aangezien de motor niet actief is.<br>Ошибка: не было достигнуто требуемое усилие опрессовки или оператор прервал процесс опрессовки вручную, когда двигатель остановился.<br>Błąd: konieczne ciśnienie nie zostało osiągnięte. Użytkownik przerwał cykl pracy ręcznie w chwili, gdy silnik nie był włączony<br>Errore: la pressione richiesta non è stata raggiunta. L'operatore ha interrotto manualmente il ciclo di pressatura mentre il motore non è in funzione. |
| <br>3 x        | <br>3 x |  | nach Arbeitsvorgang<br>after working cycle<br>après opération de travail<br>Después del proceso de trabajo<br>após o processo de trabalho<br>na bedrijfscyclus<br>после цикла опрессовки<br>po zakończeniu pracy<br>dopo il processo di lavoro  | Schwerwiegender Fehler: Pressdruck wurde bei laufendem Motor nicht erreicht.<br>Serious Error: The pressure has not been reached while the motor was running.<br>Erreur Grave: Pression pas atteinte au moteur courant.<br>Error grave: No se ha alcanzado presión mientras el motor estaba en marcha<br>Falha grave: a pressão de prensagem não foi alcançada com o motor em funcionamento.<br>Urgente foutmelding: De persdruk werd bij een werkende motor niet bereikt.<br>Серьезная ошибка: не было достигнуто требуемое усилие опрессовки во время работы двигателя<br>Poważny błąd: konieczne ciśnienie nie zostało osiągnięte podczas pracy silnika<br>Errore grave: la pressione non è stata raggiunta mentre il motore è in funzione.  |





Tab. 2

| geeignet für<br>suitable for   | <b>K13</b><br>SERIE | Verb.<br>material<br>Connection<br>material | Pressbereich<br>mm <sup>2</sup><br>Crimping<br>range mm <sup>2</sup> | Press-<br>form<br>Crimping<br>mold | Kennzeichnung<br>Marking |                       |
|--|---------------------|---|--|------------------------------------|--------------------------|-----------------------|
| Rohrkabelschuhe und Verbinder - Cu (gelb chromatiert, Pressbreite 5 mm)<br>Copper tubular cable lugs and connectors - Cu (chrome plated, crimping width 5 mm)  |                     |   |  |                                    | außen<br>outside         | Preßprofil<br>Profile |
| Rohrkabelschuhe und Verbinder „Normalausführung“, Rohrkabel-<br>schuhe für Schaltgeräteanschlüsse<br>Tubular cable lugs and connectors, „standard type“, tubular cable<br>lugs for switchgear connections  |                     |   | 16 - 400   |                                    | Cu, QS                   | QS                    |
| Isolierte Rohrkabelschuhe und Verbinder, Normalausführung<br>Insulated cable lugs and compression joints, „standard type“  |                     |   | 10 - 150   |                                    | IS, QS                   | QS                    |
| Rohrkabelschuhe und Verbinder für feindrähtige Leiter<br>Tubular cable lugs and connectors for fine stranded conductors  |                     |   | 16 - 150   |                                    | F, QS                    | QS                    |
| Presskabelschuhe und Verbinder nach DIN - Cu<br>Compression cable lugs and connectors to DIN, copper   |                     |   |  |                                    |                          |                       |
| Presskabelschuhe und Verbinder nach DIN - Cu<br>Copper compression cable lugs and connectors to DIN  |                     | <b>DIN</b>                                  | 16 - 300   |                                    | Cu, QS                   | Kennzahl              |
| Doppelpresskabelschuhe<br>Double compression cable lugs  |                     |   | 2 x 50 - 2 x 95  |                                    | DP, QS                   | QS                    |
| Quetschkabelschuhe, Verbinder und Stiftkabelschuhe nach DIN - Cu<br>Solderless terminals, connectors and pin terminals to DIN, copper  |                     |   |  |                                    |                          |                       |
| Quetschkabelschuhe (DIN 46234), Verbinder und<br>Stiftkabelschuhe (DIN 46230) nach DIN - Cu<br>Solderless terminals (DIN 46234), connectors and<br>pin terminals (DIN 46230) acc. to DIN   |                     |   | 16 - 150   |                                    | Cu, QS,<br>DIN 46234     | QS                    |
| Isolierte Quetschkabelschuhe<br>Insulated solderless terminals   |                     |   | 10 - 95  |                                    | ISQ, QS                  | QS                    |
| Hülsen für verdichtete Leiter und Sektorleiter - Cu<br>Sleeves for compacted conductors and sector shaped conductors, copper   |                     |   |  |                                    |                          |                       |
| Runddrückeinsätze für Al- und Cu-Sektorleiter<br>Pre-rounding dies for sector-shaped Al and Cu conductors  |                     |   | 10sm - 300sm   |                                    | RU, QS, sm,<br>QS, sm    | --                    |
| Presskabelschuhe und Verbinder nach DIN - Al<br>Compression cable lugs and connectors to DIN, aluminium  |                     |   |  |                                    |                          |                       |
| Presskabelschuhe und Verbinder nach DIN - Al<br>Aluminium compression cable lugs and connectors to DIN - Al  |                     |   | 10 - 240   |                                    |                          |                       |
| Pressverbinder für zugfeste Verbindungen von Aldrey-Seilen nach<br>DIN EN 50182, Al-Leiter DIN EN 50182, 120-185 mm <sup>2</sup><br>Compression joints for full-tension connections of Aldrey conductors<br>acc. to DIN EN 50182, Al-conductors DIN EN 50182, 120-185 mm <sup>2</sup>  |                     | <b>Al</b>                                   | 25 - 185   |                                    | Al, QS                   | Kennzahl              |
| Pressverbinder nach DIN 48085, Teil 3 für Al-Seile DIN EN 50182<br>Compression joints to DIN 48085, part 3 for Al-cables DIN EN 50182  |                     |   | 25 / 4 - 120 / 20  |                                    |                          |                       |
| Presskabelschuhe und Verbinder - Al/Cu<br>Compression cable lugs and connectors, Al/Cu   |                     |   |  |                                    |                          |                       |
| Presskabelschuhe und Verbinder - Al/Cu<br>Compression cable lugs and connectors - Al/Cu  |                     | <b>Al/Cu</b>                                | 10 - 240   |                                    |                          |                       |
| Klemmen und Schraubverbinder<br>Clamps and screw connectors  |                     |   |  |                                    |                          |                       |
| Abzweigklemmen C-Form<br>C-clamps  |                     |   | 10 - 70  |                                    | C, QS                    | --                    |
| Abzweigklemmen H-Form<br>H-clamps  |                     |   | 70 - 120   |                                    |                          |                       |
| Aderendhülsen<br>Cable end-sleeves   |                     |   |  |                                    |                          |                       |
| Aderendhülsen<br>Cable end-sleeves   |                     |   | 25 - 240   |                                    | AE, QS                   | --                    |
| Aderendhülsen Trapez-Sonderform für ausgedünnte<br>(„verdichtete“) feindrähtige Leiter<br>Cable end-sleeves special trapezoid crimp for<br>„compacted“ fine stranded conductors  |                     |   | 25 - 240   |                                    |                          |                       |
| <p>QS = Querschnitt/Cross-section; IS = isolierte Rohrkabelschuhe/ pre-insulated tubular cable lugs;<br/>           F = feindrähtige Leiter/ compacted fine str. conductors; ISQ = isolierte Quetschkabelschuhe/ pre-insulated tubular cable lugs;<br/>           RU = Runddrückeinsätze/ pre-rounding dies; sm = Sektorleiter mehrdrähtig/ multistranded conductors; AE = Aderendhülsen/ wire ferrules</p> <p>Bitte beachten Sie bei der Verpressung von Verbindern die Einschränkungen im technischen Anhang unseres Kataloges!<br/>           Please observe the restrictions in the technical index of our catalogue when crimping connectors!</p> |                     |   |  |                                    |                          |                       |

## Handgeführtes Elektrowerkzeug Typ EK 135FTCFB

**(D)** CE-\* - Konformitätserklärung. Wir erklären in alleiniger Verantwortlichkeit, dass dieses Produkt mit den folgenden Normen oder normativen Dokumenten übereinstimmt:

EN 62841-1, EN ISO 12100, EN ISO 13857, EN ISO 13854, EN 28662-1, EN 61000-6-3, EN 61000-6-2, EN ISO 14118 gemäß den Bestimmungen der Richtlinien 2006/42/EG, 2014/30/EU, 2011/65/EU

**(GB)** CE-\* - Declaration of conformity. We declare under our sole responsibility that this product is in conformity with the following standards or normative documents:

EN 62841-1, EN ISO 12100, EN ISO 13857, EN ISO 13854, EN 28662-1, EN 61000-6-3, EN 61000-6-2, EN ISO 14118 in accordance with the regulations of directives 2006/42/EG, 2014/30/EU, 2011/65/EU

**(F)** CE-\* - Déclaration de conformité. Nous déclarons sous notre seule responsabilité que ce produit est en conformité avec les normes ou documents normatifs suivants:

EN 62841-1, EN ISO 12100, EN ISO 13857, EN ISO 13854, EN 28662-1, EN 61000-6-3, EN 61000-6-2, EN ISO 14118 conformément aux réglementations des directives 2006/42/EG, 2014/30/EU, 2011/65/EU

**(E)** CE-\* - Declaración de conformidad. Declaramos bajo nuestra sola responsabilidad que este producto está en conformidad con las normas o documentos normativos siguientes:

EN 62841-1, EN ISO 12100, EN ISO 13857, EN ISO 13854, EN 28662-1, EN 61000-6-3, EN 61000-6-2, EN ISO 14118 de acuerdo con las regulaciones de las directivas 2006/42/EG, 2014/30/EU, 2011/65/EU

**(I)** CE-\* - Dichiarazione di conformità. Dichiariamo sotto la nostra esclusiva responsabilità che questo prodotto è conforme alle seguenti norme e documenti normativi:

EN 62841-1, EN ISO 12100, EN ISO 13857, EN ISO 13854, EN 28662-1, EN 61000-6-3, EN 61000-6-2, EN ISO 14118 conformemente alle disposizioni delle direttive 2006/42/EG, 2014/30/EU, 2011/65/EU

**(P)** CE-\* - Declaração de conformidade. Declaramos sob nossa exclusiva responsabilidade que este produto cumpre as seguintes normas ou documentos normativos:

EN 62841-1, EN ISO 12100, EN ISO 13857, EN ISO 13854, EN 28662-1, EN 61000-6-3, EN 61000-6-2, EN ISO 14118 conforme as disposições das directivas 2006/42/EG, 2014/30/EU, 2011/65/EU

**(NL)** CE-\* - Konformiteitsverklaring. Wij verklaren en wij stellen ons er alleen voor verantwoordelijk dat dit produkt voldoet aan de volgende normen of normatieve documenten:

EN 62841-1, EN ISO 12100, EN ISO 13857, EN ISO 13854, EN 28662-1, EN 61000-6-3, EN 61000-6-2, EN ISO 14118 overeenkomstig de bepalingen van de richtlijnen 2006/42/EG, 2014/30/EU, 2011/65/EU

**(GR)** CE-\* - ΔΗΛΩΣΗ ΣΥΜΜΟΡΦΩΣΗΣ Μ. ε αναληψη συνολικης δηλωνομε: οτι το πορον προιον συμφοει με τα παρακατω ποοτυπα και με τα ηροτυπα ηου αναφερονται στα σχετικο εγγραφα

EN 62841-1, EN ISO 12100, EN ISO 13857, EN ISO 13854, EN 28662-1, EN 61000-6-3, EN 61000-6-2, EN ISO 14118 σύμφωνα με τοχς κονονισμοις 2006/42/EG, 2014/30/EU, 2011/65/EU

**(S)** CE-\* - Konformitetsdeklaration. Vi förklarar på eget ansvar att denna produkt överensstämmer med följande normer eller normativa dokument:

EN 62841-1, EN ISO 12100, EN ISO 13857, EN ISO 13854, EN 28662-1, EN 61000-6-3, EN 61000-6-2, EN ISO 14118 enligt bestämmelserna i direktiverna 2006/42/EG, 2014/30/EU, 2011/65/EU

**(DK)** CE-\* - Konformitetserklæring. Vi erklærer under almindeligt ansvar at dette produkt er i overensstemmelse med følgende normer eller normative dokumenter: EN 62841-1, EN ISO 12100, EN ISO 13857, EN ISO 13854, EN 28662-1, EN 61000-6-3, EN 61000-6-2, EN ISO 14118 i henhold til bestemmelserne i direktiverne 2006/42/EØF, 2014/30/EU, 2011/65/EU

**(N)** CE-\* - Konformitetserklæring. Vi erklærer på eget ansvarighet at dette produkt er i overensstemmelse med følgende standarder eller standard-dokumenter: EN 62841-1, EN ISO 12100, EN ISO 13857, EN ISO 13854, EN 28662-1, EN 61000-6-3, EN 61000-6-2, EN ISO 14118 i henhold til bestemmelsene i direktivene 2006/42/EØF, 2014/30/EU, 2011/65/EU

**(FIN)** CE-\* - Todistus standardinmukaisuudesta. Asiasta vastaavana todistamme täten, että tämä tuote on seuraavien standardien ja standardoimisasiakirjojen vaatimusten mukainen:

EN 62841-1, EN ISO 12100, EN ISO 13857, EN ISO 13854, EN 28662-1, EN 61000-6-3, EN 61000-6-2, EN ISO 14118 ja vastaa säädöksiä 2006/42/EG, 2014/30/EU, 2011/65/EU

**(SK)** CE-\* - Prehľadzenie o zhode. Prehlasujeme na vlastnú zodpovednosť, že tieto produkty sú v súlade s nasledovnými normami:

EN 62841-1, EN ISO 12100, EN ISO 13857, EN ISO 13854, EN 28662-1, EN 61000-6-3, EN 61000-6-2, EN ISO 14118 a v zhode so smernicami 2006/42/EG, 2014/30/EU, 2011/65/EU

**(PL)** CE-\* - Zgodność z dyrektywami UKCA. Świadomi odpowiedzialności oświadczamy, że niniejszy produkt jest zgodny z następującymi normami lub dokumentacją normatywną:

EN 62841-1, EN ISO 12100, EN ISO 13857, EN ISO 13854, EN 28662-1, EN 61000-6-3, EN 61000-6-2, EN ISO 14118 zgodnie z postanowieniami wytycznych 2006/42/EG, 2014/30/EU, 2011/65/EU

**(CZ)** CE-\* - Prohlášení o shode. Prohlašujeme na vlastní zodpovednost, že tyto produkty splňují následující normy nebo normativní listiny:

EN 62841-1, EN ISO 12100, EN ISO 13857, EN ISO 13854, EN 28662-1, EN 61000-6-3, EN 61000-6-2, EN ISO 14118; Ve shode se smernicemi 2006/42/EG, 2014/30/EU, 2011/65/EU

**(SLO)** CE-\* - Izjava o skladnosti. S tem potrjujemo splošno odgovornost, da je ta izdelek narejen v skladu z navedenimi normami in standardi:

EN 62841-1, EN ISO 12100, EN ISO 13857, EN ISO 13854, EN 28662-1, EN 61000-6-3, EN 61000-6-2, EN ISO 14118 ter določbami in smernicami 2006/42/EG, 2014/30/EU, 2011/65/EU

**(HR)** CE-\* - Izjava o skladnosti. Pod punom odgovornošću izjavljujemo da je proizvod naveden u naslovu ovog dokumenta sukladan sa primjenjenim normama i normativnim dokumentima:

EN 62841-1, EN ISO 12100, EN ISO 13857, EN ISO 13854, EN 28662-1, EN 61000-6-3, EN 61000-6-2, EN ISO 14118 u skladu sa odredbama preporuka 2006/42/EG, 2014/30/EU, 2011/65/EU

**(H)** CE-\* - Megfelelősségi nyilatkozat. Kéziműködtetésű elektromos kéziszerszámok: Teljes felelősséggel kijelentjük, hogy ezek a termékek a következő szabványokkal és irányelvekkel összhangban vannak:

EN 62841-1, EN ISO 12100, EN ISO 13857, EN ISO 13854, EN 28662-1, EN 61000-6-3, EN 61000-6-2, EN ISO 14118; és megfelelnek a rendeltetés szerinti 2006/42/EG, 2014/30/EU, 2011/65/EU irányelveknek.

**(RO)** CE-\* - Declarație de conformitate. Noi declarăm pe propria răspundere că acest produs este în conformitate cu următoarele norme și documente normative: EN 62841-1, EN ISO 12100, EN ISO 13857, EN ISO 13854, EN 28662-1, EN 61000-6-3, EN 61000-6-2, EN ISO 14118; potrivit dispozițiilor directivelor 2006/42/EG, 2014/30/EU, 2011/65/EU

Remscheid, 22.02.2022



Joh. - Christoph Schütz

Dipl.-Ing. Joh.-Christoph Schütz, CE-Representative

## Handgeführtes Elektrowerkzeug Typ EK 135FTCFB

**(D)** CE-\* - Konformitätserklärung **RED**. Wir erklären in alleiniger Verantwortung, daß dieses Produkt mit den folgenden Normen oder normativen Dokumenten übereinstimmt:

BS EN IEC 62368-1, ETSI EN 301489-1, ETSI EN 301489-17, ETSI EN 300328 V2.2.2, BS EN 62479 gemäß den Bestimmungen der Richtlinien 2014/53/EU, 2011/65/EU

**(GB)** CE-\* - Declaration of conformity **RED**. We declare under our sole responsibility that this product is in conformity with the following standards or normative documents:

BS EN IEC 62368-1, ETSI EN 301489-1, ETSI EN 301489-17, ETSI EN 300328 V2.2.2, BS EN 62479 in accordance with the regulations of directives 2014/53/EU, 2011/65/EU

**(F)** CE-\* - Déclaration de conformité **RED**. Nous déclarons sous notre seule responsabilité que ce produit est en conformité avec les normes ou documents normatifs suivants:

BS EN IEC 62368-1, ETSI EN 301489-1, ETSI EN 301489-17, ETSI EN 300328 V2.2.2, BS EN 62479 conformément aux réglementations des directives 2014/53/EU, 2011/65/EU

**(E)** CE-\* - Declaración de conformidad **RED**. Declaramos bajo nuestra sola responsabilidad que este producto está en conformidad con las normas o documentos normativos siguientes:

BS EN IEC 62368-1, ETSI EN 301489-1, ETSI EN 301489-17, ETSI EN 300328 V2.2.2, BS EN 62479 de acuerdo con las regulaciones de las directivas 2014/53/EU, 2011/65/EU

**(I)** CE-\* - Dichiarazione di conformità **RED**. Dichiariamo sotto la nostra esclusiva responsabilità che questo prodotto è conforme alle seguenti norme e documenti normativi:

BS EN IEC 62368-1, ETSI EN 301489-1, ETSI EN 301489-17, ETSI EN 300328 V2.2.2, BS EN 62479 conformemente alle disposizioni delle direttive 2014/53/EU, 2011/65/EU

**(P)** CE-\* - Declaração de conformidade **RED**. Declaramos sob nossa exclusiva responsabilidade que este produto cumpre as seguintes normas ou documentos normativos:

BS EN IEC 62368-1, ETSI EN 301489-1, ETSI EN 301489-17, ETSI EN 300328 V2.2.2, BS EN 62479 conforme as disposições das directivas 2014/53/EU, 2011/65/EU

**(NL)** CE-\* - Konformiteitsverklaring **RED**. Wij verklaren en wij stellen ons er alleen voor verantwoordelijk dat dit product voldoet aan de volgende normen of normatieve documenten:

BS EN IEC 62368-1, ETSI EN 301489-1, ETSI EN 301489-17, ETSI EN 300328 V2.2.2, BS EN 62479 overeenkomstig de bepalingen van de richtlijnen 2014/53/EU, 2011/65/EU

**(GR)** CE-\* - ΔΗΛΩΣΗ ΣΥΜΜΟΡΦΩΣΗΣ Μ **RED**. ε αναληψη συνολικης δηλωνομε: οτι το πορον προιον συμφωνει με τα παρακατω ποστυπα και με τα ηροτυπα ηου αναφερονται στα σχεπκο εγγραφα

BS EN IEC 62368-1, ETSI EN 301489-1, ETSI EN 301489-17, ETSI EN 300328 V2.2.2, BS EN 62479 σύμφωνα με τοχς κονονισμοις 2014/53/EU, 2011/65/EU

**(S)** CE-\* - Konformitetsdeklaration **RED**. Vi förklarar på eget ansvar att denna produkt överensstämmer med följande normer eller normativa dokument:

BS EN IEC 62368-1, ETSI EN 301489-1, ETSI EN 301489-17, ETSI EN 300328 V2.2.2, BS EN 62479 enligt bestämmelserna i direktiverna 2014/53/EU, 2011/65/EU

**(DK)** CE-\* - Konformitetserklæring **RED**. Vi erklærer under almindeligt ansvar at dette produkt er i overensstemmelse med følgende normer eller normative dokumenter:

BS EN IEC 62368-1, ETSI EN 301489-1, ETSI EN 301489-17, ETSI EN 300328 V2.2.2, BS EN 62479 i henhold til bestemmelserne i direktiverne 2014/53/EU, 2011/65/EU

**(N)** CE-\* - Konformitetserklæring **RED**. Vi erklærer på eget ansvarlighet at dette produkt er i overensstemmelse med følgende standarder eller standard-dokumenter:

BS EN IEC 62368-1, ETSI EN 301489-1, ETSI EN 301489-17, ETSI EN 300328 V2.2.2, BS EN 62479 i henhold til bestemmelserne i direktive ne 2014/53/EU, 2011/65/EU

**(FIN)** CE-\* - Todistus standardinmukaisuudesta **RED**. Asiasta vastaavana todistamme täten, että tämä tuote on seuraavien standardien ja standardoimisasiakirjojen vaatimusten mukainen:

BS EN IEC 62368-1, ETSI EN 301489-1, ETSI EN 301489-17, ETSI EN 300328 V2.2.2, BS EN 62479 ja vastaa säädöksiä 2014/53/EU, 2011/65/EU

**(SK)** CE-\* - Prehlásenie o zhode **RED**. Prehlasujeme na vlastnú zodpovednosť, že tieto produkty sú v súlade s nasledovnými normami:

BS EN IEC 62368-1, ETSI EN 301489-1, ETSI EN 301489-17, ETSI EN 300328 V2.2.2, BS EN 62479 a v zhode so smernicami 2014/53/EU, 2011/65/EU

**(PL)** CE-\* - Zgodność z dyrektywami **RED**. Świadomi odpowiedzialności oświadczamy, że niniejszy produkt jest zgodny z następującymi normami lub dokumentacją normatywną: EN 62368-1, EN 301489-1, EN 301489-17, EN 300328 V2.2.2, EN 62479 zgodnie z postanowieniami wytycznych 2014/53/EU, 2011/65/EU

**(CZ)** CE-\* - Prohlášení o shode **RED**. Prohlasujeme na vlastní zodpovednosť, že tyto produkty splňují následující normy nebo normativní listiny: BS EN IEC 62368-1, ETSI EN 301489-1, ETSI EN 301489-17, ETSI EN 300328 V2.2.2, BS EN 62479 ve shode se smernicami 2014/53/EU, 2011/65/EU

**(SLO)** CE-\* - Izjava o skladnosti **RED**. S tem potrjujemo splošno odgovornost, da je ta izdelek narejen v skladu z navedenimi normami in standardi

BS EN IEC 62368-1, ETSI EN 301489-1, ETSI EN 301489-17, ETSI EN 300328 V2.2.2, BS EN 62479 ter določbami in smernicami 2014/53/EU, 2011/65/EU

**(HR)** CE-\* - Izjava o skladnosti **RED**. Pod punom odgovornošću izjavljujemo da je proizvod naveden u naslovu ovog dokumenta sukladan sa primijenjenim normama i normativnim dokumentima :

BS EN IEC 62368-1, ETSI EN 301489-1, ETSI EN 301489-17, ETSI EN 300328 V2.2.2, BS EN 62479 u skladu sa odredbama preporuka 2014/53/EU, 2011/65/EU

**(H)** CE-\* - Megfelelőségi nyilatkozat **RED**. Kéziműködtetésű elektromos kéziszerszámok. Teljes felelősséggel kijelentjük, hogy ezek a termékek a következő szabványokkal és irányelvekkel összhangban vannak:

BS EN IEC 62368-1, ETSI EN 301489-1, ETSI EN 301489-17, ETSI EN 300328 V2.2.2, BS EN 62479 és megfelelnek a rendeltetés 2014/53/EU, 2011/65/EU irányelveknek.

**(RO)** CE-\* - Declarație de conformitate **RED**. Noi declarăm pe propria răspundere că acest produs este în conformitate cu următoarele norme și documente normative:

BS EN IEC 62368-1, ETSI EN 301489-1, ETSI EN 301489-17, ETSI EN 300328 V2.2.2, BS EN 62479 potrivit dispozițiilor directivelor 2014/53/EU, 2011/65/EU

Remscheid, 22.02.20022



Joh. - Christoph Schütz

Dipl.-Ing. Joh.-Christoph Schütz, CE-Representative

## Handgeführtes Elektrowerkzeug Typ EK 135FTCFB

**(D) UKCA-\*** - Konformitätserklärung. Wir erklären in alleiniger Verantwortlichkeit, dass dieses Produkt mit den folgenden Normen oder normativen Dokumenten übereinstimmt:

BS EN 62841-1, BS EN ISO 12100, BS EN ISO 13857, BS EN ISO 13854, BS EN 28662-1, BS EN 61000-6-3, BS EN 61000-6-2, BS EN ISO 14118 gemäß den Bestimmungen der Richtlinien 2006/42/EG, 2014/30/EU, 2011/65/EU  
**RED:** BS EN IEC 62368-1, ETSI EN 301489-1, ETSI EN 301489-17, ETSI EN 300328 V2.2.2, BS EN 62479 gemäß den Bestimmungen der Richtlinien 2014/53/EU, 2011/65/EU

**(GB) UKCA-\*** - Declaration of conformity. We declare under our sole responsibility that this product is in conformity with the following standards or normative documents:

BS EN 62841-1, BS EN ISO 12100, BS EN ISO 13857, BS EN ISO 13854, BS EN 28662-1, BS EN 61000-6-3, BS EN 61000-6-2, BS EN ISO 14118 in accordance with the regulations of directives 2006/42/EG, 2014/30/EU, 2011/65/EU  
**RED:** BS EN IEC 62368-1, ETSI EN 301489-1, ETSI EN 301489-17, ETSI EN 300328 V2.2.2, BS EN 62479 in accordance with the regulations of directives 2014/53/EU, 2011/65/EU

**(F) UKCA-\*** - Déclaration de conformité. Nous déclarons sous notre seule responsabilité que ce produit est en conformité avec les normes ou documents normatifs suivants:

BS EN 62841-1, BS EN ISO 12100, BS EN ISO 13857, BS EN ISO 13854, BS EN 28662-1, BS EN 61000-6-3, BS EN 61000-6-2, BS EN ISO 14118 conformément aux réglementations des directives 2006/42/EG, 2014/30/EU, 2011/65/EU  
**RED:** BS EN IEC 62368-1, ETSI EN 301489-1, ETSI EN 301489-17, ETSI EN 300328 V2.2.2, BS EN 62479 conformément aux réglementations des directives 2014/53/EU, 2011/65/EU

**(E) UKCA-\*** - Declaración de conformidad. Declaramos bajo nuestra sola responsabilidad que este producto está en conformidad con las normas o documentos normativos siguientes:

BS EN 62841-1, BS EN ISO 12100, BS EN ISO 13857, BS EN ISO 13854, BS EN 28662-1, BS EN 61000-6-3, BS EN 61000-6-2, BS EN ISO 14118 de acuerdo con las regulaciones de las directivas 2006/42/EG, 2014/30/EU, 2011/65/EU  
**RED:** BS EN IEC 62368-1, ETSI EN 301489-1, ETSI EN 301489-17, ETSI EN 300328 V2.2.2, BS EN 62479 de acuerdo con las regulaciones de las directivas 2014/53/EU, 2011/65/EU

**(I) UKCA-\*** - Dichiarazione di conformità. Dichiariamo sotto la nostra esclusiva responsabilità che questo prodotto è conforme alle seguenti norme e documenti normativi:

BS EN 62841-1, BS EN ISO 12100, BS EN ISO 13857, BS EN ISO 13854, BS EN 28662-1, BS EN 61000-6-3, BS EN 61000-6-2, BS EN ISO 14118 conformemente alle disposizioni delle direttive 2006/42/EG, 2014/30/EU, 2011/65/EU  
**RED:** BS EN IEC 62368-1, ETSI EN 301489-1, ETSI EN 301489-17, ETSI EN 300328 V2.2.2, BS EN 62479 conformemente alle disposizioni delle direttive 2014/53/EU, 2011/65/EU

**(P) UKCA-\*** - Declaração de conformidade. Declaramos sob nossa exclusiva responsabilidade que este produto cumpre as seguintes normas ou documentos normativos:

BS EN 62841-1, BS EN ISO 12100, BS EN ISO 13857, BS EN ISO 13854, BS EN 28662-1, BS EN 61000-6-3, BS EN 61000-6-2, BS EN ISO 14118 conforme as disposições das directivas 2006/42/EG, 2014/30/EU, 2011/65/EU  
**RED:** BS EN IEC 62368-1, ETSI EN 301489-1, ETSI EN 301489-17, ETSI EN 300328 V2.2.2, BS EN 62479 conforme as disposições das directivas 2014/53/EU, 2011/65/EU

**(NL) UKCA-\*** - Konformiteitsverklaring. Wij verklaren en wij stellen ons er alleen voor verantwoordelijk dat dit produkt voldoet aan de volgende normen of normatieve documenten:

BS EN 62841-1, BS EN ISO 12100, BS EN ISO 13857, BS EN ISO 13854, BS EN 28662-1, BS EN 61000-6-3, BS EN 61000-6-2, BS EN ISO 14118 overeenkomstig de bepalingen van de richtlijnen 2006/42/EG, 2014/30/EU, 2011/65/EU  
**RED:** BS EN IEC 62368-1, ETSI EN 301489-1, ETSI EN 301489-17, ETSI EN 300328 V2.2.2, BS EN 62479 overeenkomstig de bepalingen van de richtlijnen 2014/53/EU, 2011/65/EU

**(GR) UKCA-\*** - ΔΗΛΩΣΗ ΣΥΜΜΟΡΦΩΣΗΣ Μ. Ε αναλήψη συνολικής δηλωόμε: ότι το πορον προιον συμφοει με τα παρακατω ποστυπα και με τα προτυπα ηου αναφειρονται στα σχετικο εγγραφα

BS EN 62841-1, BS EN ISO 12100, BS EN ISO 13857, BS EN ISO 13854, BS EN 28662-1, BS EN 61000-6-3, BS EN 61000-6-2, BS EN ISO 14118 σύμφωνα με τους κανονισμούς 2006/42/EG, 2014/30/EU, 2011/65/EU  
**RED:** BS EN IEC 62368-1, ETSI EN 301489-1, ETSI EN 301489-17, ETSI EN 300328 V2.2.2, BS EN 62479 σύμφωνα με τους κανονισμούς 2014/53/EU, 2011/65/EU

**(S) UKCA-\*** - Konformitetsdeklaration. Vi förklarar på eget ansvar att denna produkt överensstämmer med följande normer eller normativa dokument:

BS EN 62841-1, BS EN ISO 12100, BS EN ISO 13857, BS EN ISO 13854, BS EN 28662-1, BS EN 61000-6-3, BS EN 61000-6-2, BS EN ISO 14118 enligt bestämmelserna i direktiverna 2006/42/EG, 2014/30/EU, 2011/65/EU  
**RED:** BS EN IEC 62368-1, ETSI EN 301489-1, ETSI EN 301489-17, ETSI EN 300328 V2.2.2, BS EN 62479 enligt bestämmelserna i direktiverna 2014/53/EU, 2011/65/EU

**(DK) UKCA-\*** - Konformitetserklæring. Vi erklærer under almindeligt ansvar at dette produkt er i overensstemmelse med følgende normer eller normative dokumenter:

BS EN 62841-1, BS EN ISO 12100, BS EN ISO 13857, BS EN ISO 13854, BS EN 28662-1, BS EN 61000-6-3, BS EN 61000-6-2, BS EN ISO 14118 i henhold til bestemmelserne i direktiverne 2006/42/EØF, 2014/30/EU, 2011/65/EU  
**RED:** BS EN IEC 62368-1, ETSI EN 301489-1, ETSI EN 301489-17, ETSI EN 300328 V2.2.2, BS EN 62479 i henhold til bestemmelserne i direktiverne 2014/53/EU, 2011/65/EU

**(N) UKCA-\*** - Konformitetserklæring. Vi erklærer på eget ansvar at dette produkt er i overensstemmelse med følgende standarder eller standard-dokumenter: BS EN 62841-1, BS EN ISO 12100, BS EN ISO 13857, BS EN ISO 13854, BS EN 28662-1, BS EN 61000-6-3, BS EN 61000-6-2, BS EN ISO 14118 i henhold til bestemmelserne i direktive ne 2006/42/EØF, 2014/30/EU, 2011/65/EU

**RED:** BS EN IEC 62368-1, ETSI EN 301489-1, ETSI EN 301489-17, ETSI EN 300328 V2.2.2, BS EN 62479 i henhold til bestemmelserne i direktive ne 2014/53/EU, 2011/65/EU

**(FIN) UKCA-\*** - Todistus standardinmukaisuudesta. Asiaasta vastaavana todistamme täten, että tämä tuote on seuraavien standardien ja standardoimisasiakirjojen vaatimusten mukainen:

BS EN 62841-1, BS EN ISO 12100, BS EN ISO 13857, BS EN ISO 13854, BS EN 28662-1, BS EN 61000-6-3, BS EN 61000-6-2, BS EN ISO 14118 ja vastaa säädöksiä 2006/42/EG, 2014/30/EU, 2011/65/EU

**RED:** BS EN IEC 62368-1, ETSI EN 301489-1, ETSI EN 301489-17, ETSI EN 300328 V2.2.2, BS EN 62479 ja vastaa säädöksiä 2014/53/EU, 2011/65/EU

**(SK) UKCA-\*** - Prehľadzenie o zhode. Prehlasujeme na vlastnú zodpovednosť, že tieto produkty sú v súlade s nasledovnými normami:

BS EN 62841-1, BS EN ISO 12100, BS EN ISO 13857, BS EN ISO 13854, BS EN 28662-1, BS EN 61000-6-3, BS EN 61000-6-2, BS EN ISO 14118 a v zhode so smernicami 2006/42/EG, 2014/30/EU, 2011/65/EU

**RED:** BS EN IEC 62368-1, ETSI EN 301489-1, ETSI EN 301489-17, ETSI EN 300328 V2.2.2, BS EN 62479 a v zhode so smernicami 2014/53/EU, 2011/65/EU

**(PL) UKCA-\*** - Zgodność z dyrektywami UKCA. Świadomi odpowiedzialności oświadczamy, że niniejszy produkt jest zgodny z następującymi normami lub dokumentacja normatywna:

BS EN 62841-1, BS EN ISO 12100, BS EN ISO 13857, BS EN ISO 13854, BS EN 28662-1, BS EN 61000-6-3, BS EN 61000-6-2, BS EN ISO 14118 zgodnie z postanowieniami wytycznych 2006/42/EG, 2014/30/EU, 2011/65/EU

**RED:** BS EN IEC 62368-1, ETSI EN 301489-1, ETSI EN 301489-17, ETSI EN 300328 V2.2.2, BS EN 62479 zgodnie z postanowieniami wytycznych 2014/53/EU, 2011/65/EU

**(CZ) UKCA-\*** - Prohlášení o shode. Prohlašujeme na vlastní zodpovednosť, že tyto produkty splňují následující normy nebo normativní listiny:

BS EN 62841-1, BS EN ISO 12100, BS EN ISO 13857, BS EN ISO 13854, BS EN 28662-1, BS EN 61000-6-3, BS EN 61000-6-2, BS EN ISO 14118; Ve shode se směrnicemi 2006/42/EG, 2014/30/EU, 2011/65/EU

**RED:** BS EN IEC 62368-1, ETSI EN 301489-1, ETSI EN 301489-17, ETSI EN 300328 V2.2.2, BS EN 62479 Ve shode se směrnicemi 2014/53/EU, 2011/65/EU

**(SLO) UKCA-\*** - Izjava o skladnosti. S tem potrjujemo splošno odgovornost, da je ta izdelek narejen v skladu z navedenimi normami in standardi: BS EN 62841-1, BS EN ISO 12100, BS EN ISO 13857, BS EN ISO 13854, BS EN 28662-1, BS EN 61000-6-3, BS EN 61000-6-2, BS EN ISO 14118 ter določbami in smernicami 2006/42/EG, 2014/30/EU, 2011/65/EU

**RED:** BS EN IEC 62368-1, ETSI EN 301489-1, ETSI EN 301489-17, ETSI EN 300328 V2.2.2, BS EN 62479 ter določbami in smernicami 2014/53/EU, 2011/65/EU

**(HR) UKCA-\*** - Izjava o skladnosti. Pod punom odgovornošću izjavljujemo da je proizvod naveden u naslovu ovog dokumenta sukladan sa primijenjenim normama i normativnim dokumentima:

BS EN 62841-1, BS EN ISO 12100, BS EN ISO 13857, BS EN ISO 13854, BS EN 28662-1, BS EN 61000-6-3, BS EN 61000-6-2, BS EN ISO 14118 u skladu sa odredbama preporuka 2006/42/EG, 2014/30/EU, 2011/65/EU

**RED:** BS EN IEC 62368-1, ETSI EN 301489-1, ETSI EN 301489-17, ETSI EN 300328 V2.2.2, BS EN 62479 u skladu sa odredbama preporuka 2014/53/EU, 2011/65/EU

**(H) UKCA-\*** - Megfelelőségi nyilatkozat. Kéziműködtetésű elektromos kéziszerszámok: Teljes felelősséget kijelentünk, hogy ezek a termékek a következő szabványokkal és irányelvekkel összhangban vannak:

BS EN 62841-1, BS EN ISO 12100, BS EN ISO 13857, BS EN ISO 13854, BS EN 28662-1, BS EN 61000-6-3, BS EN 61000-6-2, BS EN ISO 14118; és megfelelnek a rendeltetés szerinti 2006/42/EG, 2014/30/EU, 2011/65/EU irányelveknek.

**RED:** BS EN IEC 62368-1, ETSI EN 301489-1, ETSI EN 301489-17, ETSI EN 300328 V2.2.2, BS EN 62479 és megfelelnek a rendeltetés 2014/53/EU, 2011/65/EU irányelveknek.

**(RO) UKCA-\*** - Declarație de conformitate. Noi declarăm pe propria răspundere că acest produs este în conformitate cu următoarele norme și documente normative:

BS EN 62841-1, BS EN ISO 12100, BS EN ISO 13857, BS EN ISO 13854, BS EN 28662-1, BS EN 61000-6-3, BS EN 61000-6-2, BS EN ISO 14118; potrivit dispozițiilor directivei 2006/42/EG, 2014/30/EU, 2011/65/EU

**RED:** BS EN IEC 62368-1, ETSI EN 301489-1, ETSI EN 301489-17, ETSI EN 300328 V2.2.2, BS EN 62479 potrivit dispozițiilor directivei 2014/53/EU, 2011/65/EU

Remscheid, 22.02.2022



Joh. - Christoph Schütz  
Dipl.-Ing. Joh.-Christoph Schütz, CE-Representative