



www.klauke.com

EBS8CFM



Serialnumber

HE.17092_G © 05/2016 R&D-2



Gustav Klauke GmbH • Auf dem Knapp 46 • D-42855 Remscheid • Telefon +49 2191 907 0 • www.klauke.com

Klauke®

**2 Jahre
Garantie**

Wir freuen uns, dass Sie sich für ein Klauke Werkzeug entschieden haben und wünschen Ihnen viel Freude damit.

**Weltweiter
Werkzeug
Service**
Klauke ASC
Authorized Service Center

Sie haben ein Qualitätsprodukt „Made in Germany“ erworben und erhalten 2 Jahre Garantie. Diese beginnt mit dem Kaufbelegdatum.

Um lange Freude und eine einwandfreie Funktion des Werkzeuges sicherzustellen, muss das Gerät spätestens beim Erreichen von 10.000 Arbeitsvorgängen oder nach 3 Jahren durch ein Autorisiertes Service Center (ASC) gewartet werden. Wird das Wartungsintervall von 10.000 Arbeitsvorgängen nicht eingehalten, erlischt der Garantieanspruch.

Im Rahmen dieser Wartung werden verschlissene Teile ersetzt und sicherheitsrelevante Teile geprüft und ggf. vorbeugend ersetzt.

Darüber hinaus empfehlen wir das Gerät jährlich zur Überprüfung an das zuständige ASC einzusenden.

Für Fragen rund um unseren Werkzeugservice stehen wir Ihnen unter folgenden Rufnummern persönlich zur Verfügung:

Technik +492332709544

Reparaturen / Leihgeräte +492332709540



Ihr Klauke-Service Team



Die Bluetooth®-Wortmarke und das Bluetooth®-Symbol sind eingetragene Warenzeichen der Bluetooth SIG, Inc. und jegliche Verwendung durch Gustav Klauke GmbH ist lizenziert.

**2 years
Warranty**

Thank you for choosing a Klauke tool. We hope it gives you lots of pleasure.

**World wide
Tool
Service**
Klauke ASC
Authorized Service Center

You have purchased a quality product „Made in Germany“, which is covered by a 2 year warranty. The warranty commences from the purchase receipt date.

To ensure lasting enjoyment and a flawless tool function, the product must be serviced by an Authorised Service Center (ASC) after 10,000 operations or after 3 years. Should the service Interval exceed 10.000 cycles the warranty claim is void.

The Service includes predictive maintenance in which worn-out parts will be replaced and safety relevant parts checked/replaced.

We recommend to have the tools checked yearly through an Authorized Service Center (ASC).

For questions about our tool service we are personally available under the following telephone numbers:

Technical Support +492332709544

Repairs / Loaner tools +492332709540



Your Klauke-Service Team



The Bluetooth® word mark and Bluetooth® symbol are registered trademarks of Bluetooth SIG, Inc. and any use by Gustav Klauke GmbH is licensed.



EBS8CFM

Klauke

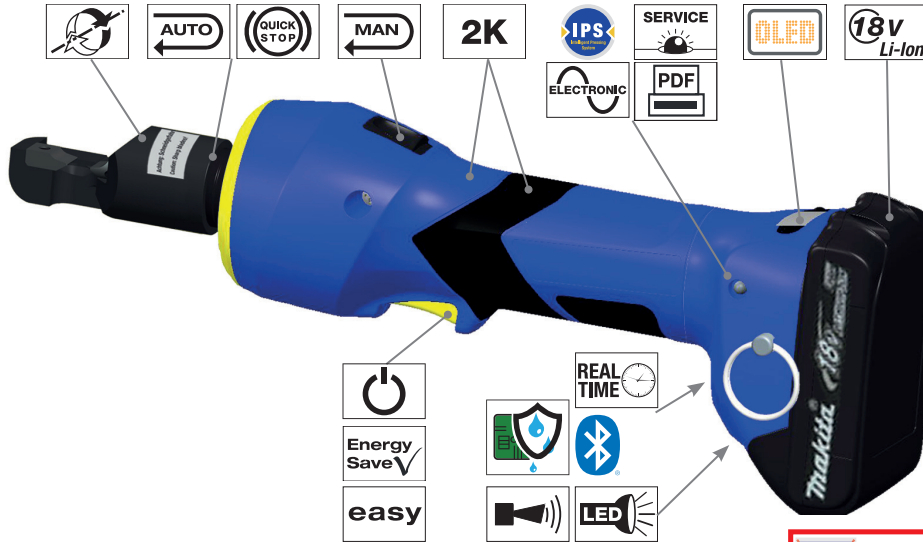

optional:
BL1850(B) (RAL4)
BL1840(B) (RAL40)
BL1830(B) (RAL2)



datecode

Year	Code	Month	Code	Month	Code
2022	R	Jan.	N	July	V
2023	S	Feb.	P	Aug.	W
2024	T	Mar.	Q	Sept.	X
2025	V	Apr.	R	Oct.	Y
2026	W	May	S	Nov.	Z
2027	X	June	T	Dec.	1

For US and Canada only

FCC ID: RFR-850 • IC: 4957A-S50
 Model: CFM
 This device complies with Part 15 of the FCC Rules and with Industry Canada licence-exempt RSS standard(s). Operation is subject to the following two conditions: (1) this device may not cause harmful interference, and (2) this device must accept any interference received, including interference that may cause undesired operation.
 HE.0055

batch# e.g. 304711
 datecode e.g. X = 2027; R = April
 consecutive# e.g. „142“ = tool # 142

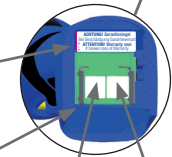

304711
XR
142

Klauke
Auf dem Knapp 46
D-42855
Remscheid





EBS8CFM

Klauke

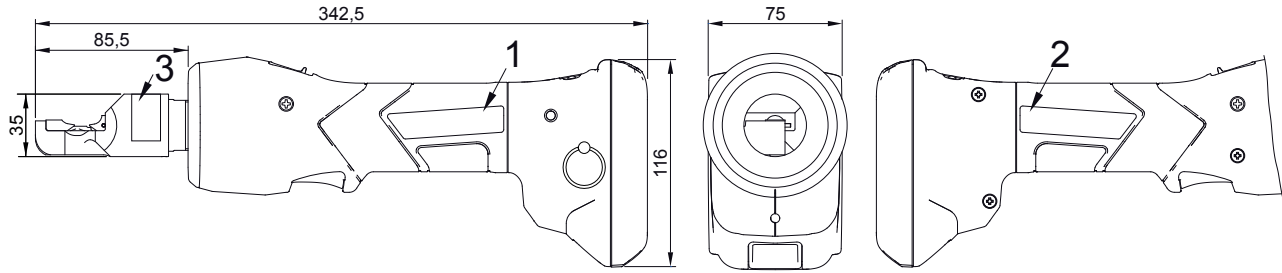

1

Next Generation
Klauke mini
made in Germany

CE UK CA EAC 50
HE 17092_G E

2

EBS8CFM
Cutting tool • Ø 8 mm • 18 V ==
Gustav Klauke GmbH • Auf dem Knapp 46 • D-42855 Reimscheid
For use only with Klauke FALKYBox and Makita BL18xx battery series

292342
HE 17092_G



<70dB
 VIBR <2,5m/s²

1,7 kg

+40°C
-10°C

BiO

IP 44

WARNING

Read all safety warnings, instructions, illustrations and specifications provided with this power tool.

Failure to follow all instructions listed below may result in electric shock, fire and/or serious injury.

Save all warnings and instructions for future reference.

WORK



SERVICE



DON'T DO







General safety rules





EBS8CFM

Klauke

Use tool only with 18 V Makita battery









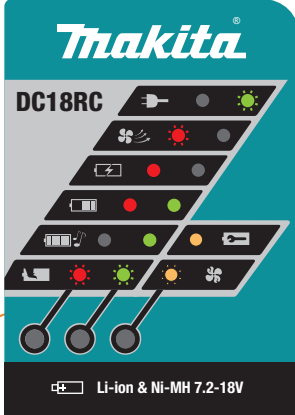















<p>BL1850(B) RAL4</p> <p>BL1840(B) RAL40</p> <p>BL1830(B) RAL2</p> <p>BL1815 RAL1</p>	 	<p>45 min.</p> <p>36 min.</p> <p>22 min.</p> <p>15 min.</p> <p>10 - 40°C</p>
---	--	--



Alle Bedienungsanleitungen auch unter www.klauke.de abrufbar
All manuals are also available on www.Klauke.com





EBS8CFM

Klauke

⚠️ ⚡ > 330° STOP

Klauke ASC
Authorized Service Center

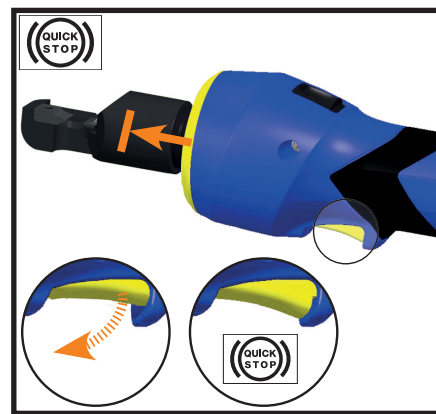
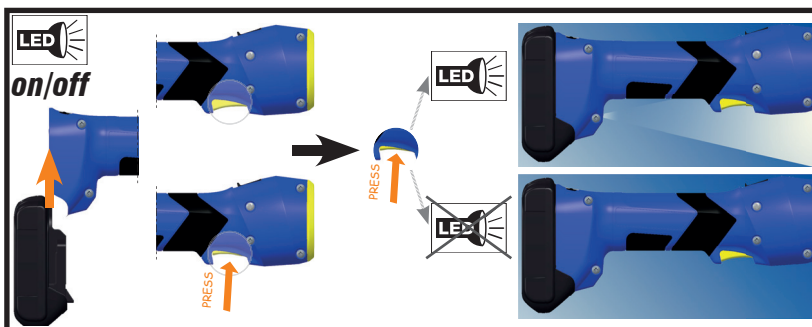
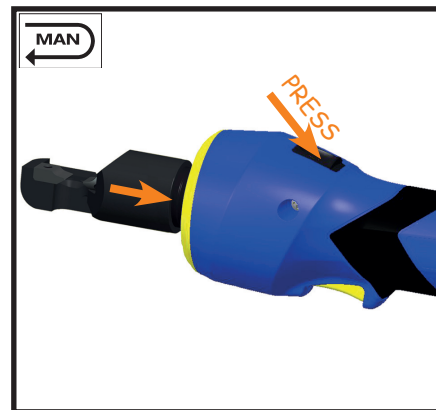



EBS8CFM

Klauke

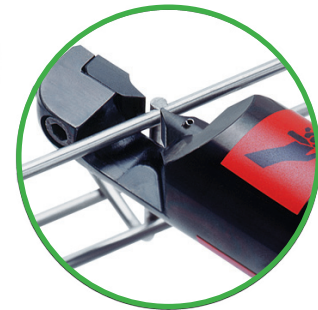
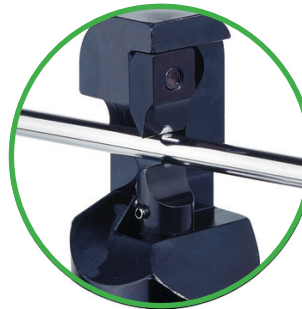
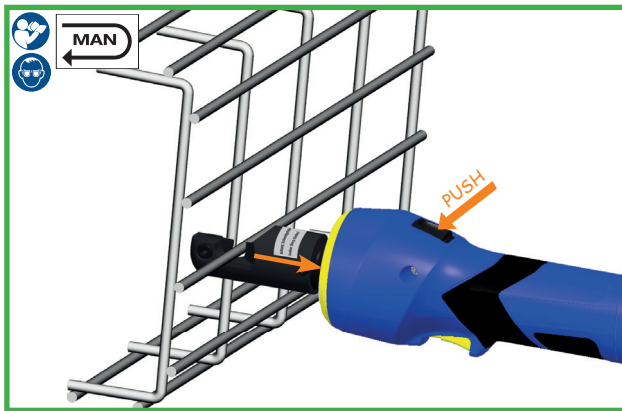
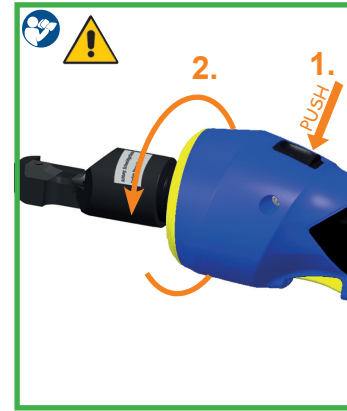
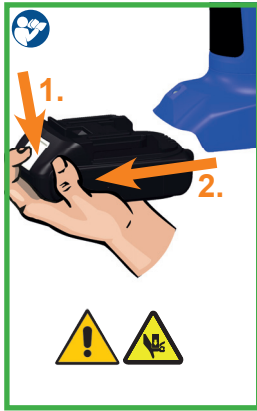

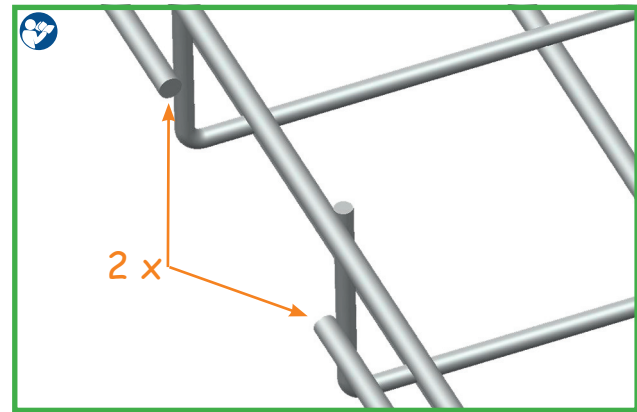
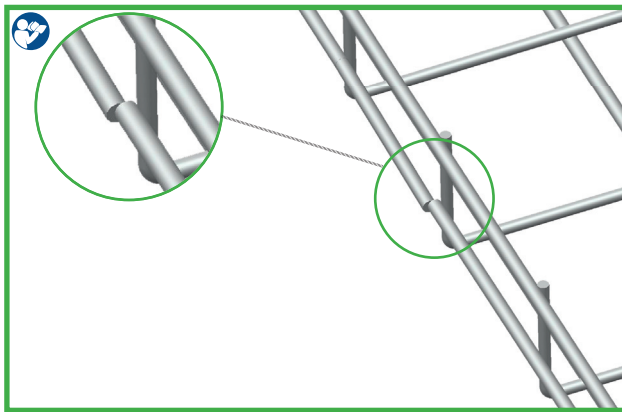
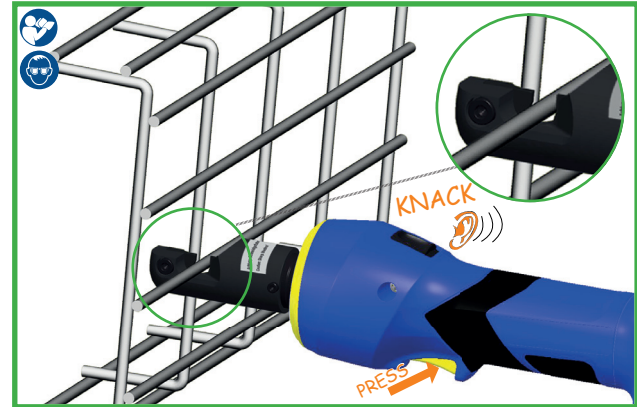
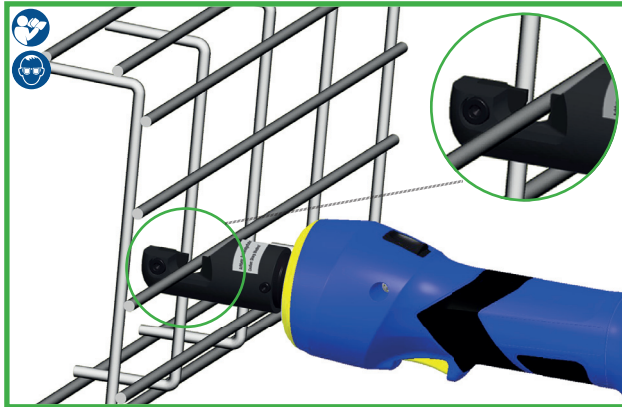



1		
2		Klauke
	ERROR CODE: ****	Error code *1
3	 BT P 3 bar P̂ 3 bar	Bluetooth (if connected) Battery charging level Current pressure Pressure max. *2
4a	 USER 3: RD3 Doppelklick	Doubleclick
4b	 USER SELECT 3: RD3 Einfachklick	Singleclick enter menue
4c	 USER SELECT: RD3 Doppelklick	Doubelclick select
4d	 USER SELECT: RD3 Doppelklick	Doubelclick confirmed

5	 NEXT SERVICE: 9826 0Ps	Cycles (until next service)
---	-------------------------------	--------------------------------

6	 TOTAL: t = 0.07 h Q = 21.12 Ah n = 174	Since manufacturing: operating hours Capacity # crimps
---	---	---

7		RETURN
---	--	---------------

- *1 Error codes/ Fehlermeldungen:
- 1 Overcurrent fuse
 - 2 Overcurrent comparator
 - 3 Overheat board
 - 4 Overheat battery
 - 5 Battery empty, operation stop
 - 6 Faulty crimp motor in operation
 - 7 Faulty crimp motor not in operation
 - 8 Low battery
 - 9 Battery empty
 - 10 RTC battery low
 - 12 Service necessary
 - 13 RTC not found
 - 14 BT unit not found
 - 15 Mobile unit not found
 - 16 Pressure sensor not found
 - 17 Burst pressure exceeded
 - 18 Battery temperature too low
 - 19 Battery reserves
 - 20 Overcurrent fuse (I)
 - 21 Remote Control Battery Low*
 - 22 Service necessary SAST1
 - 23 Service necessary SAST2
 - 24 Service necessary SAST3
 - 25 Remote mode: tool trigger not actuated*
 - 27 Overheat motor
 - 28 Service necessary: Pressure low
 - 29 Service necessary: Pressure high
- 1 Überstromsicherung
2 Überstromsicherung durch Komparator
3 Boardtemperatur zu hoch
4 Akkutemperatur zu hoch
5 Akkuspannung zu gering
6 Fehlpressung bei laufendem Motor
7 Fehlpressung bei stehendem Motor
8 Niedrige Akkuspannung
9 Akku leer
10 RTC-Batterie leer
12 Service nötig
13 RTC nicht verfügbar
14 BT-Modul nicht verfügbar
15 Modul nicht verfügbar
16 Drucksensor nicht verfügbar
17 Berstdruck überschritten
18 Akkutemperatur zu gering
19 Batteriereserven zu gering
20 Überstromsicherung (I)
21 Fernbedienung-Batterie schwach*
22 Service notwendig SAST1
23 Service notwendig SAST2
24 Service notwendig SAST3
25 Remote-Modus: WZ-Taster nicht betätigt*
27 Motortemperatur zu hoch
28 Service notwendig: Druck niedrig
29 Service notwendig: Druck hoch
* remote control tools only/
nur bei fernbedienbaren Werkzeugen

*2 (2Hz)





Klauke i-press® Software

▶ www.klauke.com/connectivity

Klauke i-press® App

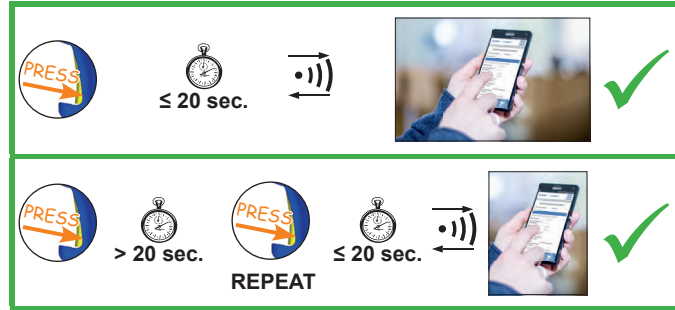

Le présent appareil est conforme aux CNR d'Industrie Canada applicables aux appareils radio exempts de licence. L'exploitation est autorisée aux deux conditions suivantes:

- (1) l'appareil ne doit pas produire de brouillage, et
- (2) l'utilisateur de l'appareil doit accepter tout brouillage radioélectrique subi, même si le brouillage est susceptible d'en compromettre le fonctionnement.

NOTICE:

Changes or modifications made to this equipment not expressly approved by Klauke may void the FCC authorization to operate this equipment.





EBS8CFM

Klauke

BEFORE WORK

DIN EN 50110

2 years Warranty
World wide Tool Service
Klauke ASC

- 1.
- 2.
- 3.

Klauke

once a year

Recommendation
Empfehlung

Klauke ASC
Authorised Service Center

3 years or 10.000 operations

OLD
PART REPLACEMENT
SAFETY
NEW

2 years Warranty
World wide Tool Service
Klauke ASC

Klauke ASC
Authorised Service Center

WEEE
2012/19/EU

Klauke-WEEE-Abholung@Emerson.com

Klauke ASC
Authorised Service Center

WORK

SERVICE

DON'T DO

General safety rules



			Wann/When/Quand/Quando/ cuándo/Wanneer/Когда/это происходит/Kiedy/quando	Warum/Why/Pourquoi/Porquê/ ¿por qué?/Waarom/Причина/ Dlaczego/Perché
 20 sec			nach Arbeitsvorgang after working cycle après opération de travail Después del proceso de trabajo após o processo de trabalho na bedrijfscyclus после цикла опрессовки po zakończeniu pracy dopo il processo di lavoro	
 20 sec/2Hz			nach Arbeitsvorgang after working cycle après opération de travail Después del proceso de trabajo após o processo de trabalho na bedrijfscyclus после цикла опрессовки po zakończeniu pracy dopo il processo di lavoro	 Klauke ASC® Authorized Service Center
 20 sec/5Hz			während der Übertemperatur while exceeding the temp. limit pendant surchauffe en caso de temperatura excesiva durante a temperatura excessiva tijdens te hoge temperatuur при высокой температуре внутри корпуса przy przegrzaniu superando il limite di temperatura	Werkzeug zu heiß Unit too hot outil surchauffé Herramienta demasiado caliente ferramenta demasiado quente gereedschap te heet Перегрев инструмента urządzenie za gorące Utensile troppo caldo



Handgeführtes batteriebetriebenes Elektrowerkzeug Typ EBS8CFM

Klauke

(D) CE-* - Konformitätserklärung. Wir erklären in alleiniger Verantwortlichkeit, daß dieses Produkt mit den folgenden Normen oder normativen Dokumenten übereinstimmt: EN 62841-1, EN ISO 12100, EN ISO 13857, EN ISO 13854, EN 28662-1, EN 61000-6-3, EN 61000-6-2, EN 60529, EN ISO 14118 gemäß den Bestimmungen der Richtlinien 2006/42/EG, 2014/30/EU, 2011/65/EU

(GB) CE-* - Declaration of conformity. We declare under our sole responsibility that this product is in conformity with the following standards or normative documents: EN 62841-1, EN ISO 12100, EN ISO 13857, EN ISO 13854, EN 28662-1, EN 61000-6-3, EN 61000-6-2, EN 60529, EN ISO 14118 in accordance with the regulations of directives 2006/42/EG, 2014/30/EU, 2011/65/EU

(F) CE-* - Déclaration de conformité. Nous déclarons sous notre seule responsabilité que ce produit est en conformité avec les normes ou documents normatifs suivants: EN 62841-1, EN ISO 12100, EN ISO 13857, EN ISO 13854, EN 28662-1, EN 61000-6-3, EN 61000-6-2, EN 60529, EN ISO 14118 conformément aux réglementations des directives 2006/42/EG, 2014/30/EU, 2011/65/EU

(E) CE-* - Declaración de conformidad. Declaramos bajo nuestra sola responsabilidad que este producto está en conformidad con las normas o documentos normativos siguientes: EN 62841-1, EN ISO 12100, EN ISO 13857, EN ISO 13854, EN 28662-1, EN 61000-6-3, EN 61000-6-2, EN 60529, EN ISO 14118 de acuerdo con las regulaciones de las directivas 2006/42/EG, 2014/30/EU, 2011/65/EU

(I) CE-* - Dichiarazione di conformità. Dichiariamo sotto la nostra esclusiva responsabilità che questo prodotto è conforme alle seguenti norme e documenti normativi: EN 62841-1, EN ISO 12100, EN ISO 13857, EN ISO 13854, EN 28662-1, EN 61000-6-3, EN 61000-6-2, EN 60529, EN ISO 14118 conformemente alle disposizioni delle direttive 2006/42/EG, 2014/30/EU, 2011/65/EU

(P) CE-* - Declaração de conformidade. Declaramos sob nossa exclusiva responsabilidade que este produto cumpre as seguintes normas ou documentos normativos: EN 62841-1, EN ISO 12100, EN ISO 13857, EN ISO 13854, EN 28662-1, EN 61000-6-3, EN 61000-6-2, EN 60529, EN ISO 14118 conforme as disposições das directivas 2006/42/EG, 2014/30/EU, 2011/65/EU

(NL) CE-* - Konformiteitsverklaring. Wij verklaren en wij stellen ons er alleen voor verantwoordelijk dat dit product voldoet aan de volgende normen of normatieve documenten: EN 62841-1, EN ISO 12100, EN ISO 13857, EN ISO 13854, EN 28662-1, EN 61000-6-3, EN 61000-6-2, EN 60529, EN ISO 14118 overeenkomstig de bepalingen van de richtlijnen 2006/42/EG, 2014/30/EU, 2011/65/EU

(GR) CE-* - ΔΗΛΩΣΗ ΣΥΜΜΟΡΦΩΣΗΣ Με αναληψη συνολικης δηλωνομε οτι το πορον προιον συμφωρει με τα παρακατω ποστυπα και με τα πρωτυπα ηου αναφερονται στα σχετικο εγγραφα EN 62841-1, EN ISO 12100, EN ISO 13857, EN ISO 13854, EN 28662-1, EN 61000-6-3, EN 61000-6-2, EN 60529, EN ISO 14118 συμφωνα με τοχς κοινοισμους 2006/42/EG, 2014/30/EU, 2011/65/EU

(S) CE-* - Konformitetsdeklaration. Vi förklarar på eget ansvar att denna produkt överensstämmer med följande normer eller normativa dokument: EN 62841-1, EN ISO 12100, EN ISO 13857, EN ISO 13854, EN 28662-1, EN 61000-6-3, EN 61000-6-2, EN 60529, EN ISO 14118 enligt bestämmelserna i direktiverna 2006/42/EG, 2014/30/EU, 2011/65/EU

(DK) CE-* - Konformitetserklæring. Vi erklærer under almindeligt ansvar at dette produkt er i overensstemmelse med følgende normer eller normative dokumenter: EN 62841-1, EN ISO 12100, EN ISO 13857, EN ISO 13854, EN 28662-1, EN 61000-6-3, EN 61000-6-2, EN 60529, EN ISO 14118 i henhold til bestemmelserne i direktiverne 2006/42/EØF, 2014/30/EU, 2011/65/EU

(N) CE-* - Konformitetserklæring. Vi erklærer på eget ansvar at dette produkt er i overensstemmelse med følgende standarder eller standard-dokumenter: EN 62841-1, EN ISO 12100, EN ISO 13857, EN ISO 13854, EN 28662-1, EN 61000-6-3, EN 61000-6-2, EN 60529, EN ISO 14118 i henhold til bestemmelserne i direktivene 2006/42/EØF, 2014/30/EU, 2011/65/EU

(FIN) CE-* - Todistus standardinmukaisuudesta. Asiaa vastaavana todistamme täten, että tämä tuote on seuraavien standardien ja standardoimisasiakirjojen vaatimusten mukainen: EN 62841-1, EN ISO 12100, EN ISO 13857, EN ISO 13854, EN 28662-1, EN 61000-6-3, EN 61000-6-2, EN 60529, EN ISO 14118 ja vastaa säädöksiä 2006/42/EG, 2014/30/EU, 2011/65/EU

(SK) CE-* - Prehlásenie o zhode. Prehlasujeme na vlastnú zodpovednosť, že tieto produkty sú v súlade s nasledovnými normami: EN 62841-1, EN ISO 12100, EN ISO 13857, EN ISO 13854, EN 28662-1, EN 61000-6-3, EN 61000-6-2, EN 60529, EN ISO 14118 a v zhode so smerniciami 2006/42/EG, 2014/30/EU, 2011/65/EU

(PL) CE-* - Zgodność z dyrektywami CE. Świadomi odpowiedzialności oświadczamy, że niniejszy produkt jest zgodny z następującymi normami lub dokumentacją normatywną: EN 62841-1, EN ISO 12100, EN ISO 13857, EN ISO 13854, EN 28662-1, EN 61000-6-3, EN 61000-6-2, EN 60529, EN ISO 14118 zgodnie z postanowieniami wytycznych 2006/42/EG, 2014/30/EU, 2011/65/EU

(CZ) CE-* - Prohlášení o shodě. Prohlasujeme na vlastní zodpovědnost, že tyto produkty splňují následující normy nebo normativní listiny: EN 62841-1, EN ISO 12100, EN ISO 13857, EN ISO 13854, EN 28662-1, EN 61000-6-3, EN 61000-6-2, EN 60529, EN ISO 14118; Ve shodě se směrnicemi 2006/42/EG, 2014/30/EU, 2011/65/EU

(SLO) CE-* - Izjava o skladnosti. S tem potrjujemo splošno odgovornost, da je ta izdelek narejen v skladu z navedenimi normami in standardi: EN 62841-1, EN ISO 12100, EN ISO 13857, EN ISO 13854, EN 28662-1, EN 61000-6-3, EN 61000-6-2, EN 60529, EN ISO 14118 ter določbami in smernicami 2006/42/EG, 2014/30/EU, 2011/65/EU

(HR) CE-* - Izjava o sukladnosti. Pod punom odgovornošću izjavljujemo da je proizvod naveden u naslovu ovog dokumenta sukladan sa primijenjenim normama i normativnim dokumentima : EN 62841-1, EN ISO 12100, EN ISO 13857, EN ISO 13854, EN 28662-1, EN 61000-6-3, EN 61000-6-2, EN 60529, EN ISO 14118 u skladu sa odredbama preporuka 2006/42/EG, 2014/30/EU, 2011/65/EU

(H) CE-* - Megfelelősségi nyilatkozat. Kéziműködtetésű elektromos kéziszerszámok: Teljes felelősséggel kijelentjük, hogy ezek a termékek a következő szabványokkal és irányelvekkel összhangban vannak: EN 62841-1, EN ISO 12100, EN ISO 13857, EN ISO 13854, EN 28662-1, EN 61000-6-3, EN 61000-6-2, EN 60529, EN ISO 14118; és megfelelnek a rendeltetés szerinti 2006/42/EG, 2014/30/EU, 2011/65/EU irányelveknek.

(RO) CE-* - Declarație de conformitate. Noi declarăm pe propria răspundere că acest produs este în conformitate cu următoarele norme și documente normative: EN 62841-1, EN ISO 12100, EN ISO 13857, EN ISO 13854, EN 28662-1, EN 61000-6-3, EN 61000-6-2, EN 60529, EN ISO 14118; potrivit dispozițiilor directivelor 2006/42/EG, 2014/30/EU, 2011/65/EU

Remscheid, 22.02.2022

CE

Joh. - Christoph Schütz

Dipl.-Ing. Joh.-Christoph Schütz, CE-Representative

*2016

(D) CE-* - Konformitätserklärung **RED**. Wir erklären in alleiniger Verantwortlichkeit, daß dieses Produkt mit den folgenden Normen oder normativen Dokumenten übereinstimmt: EN IEC 62368-1, ETSI EN 301489-1, ETSI EN 301489-17, ETSI EN 300328 V2.2.2, EN 62479 gemäß den Bestimmungen der Richtlinien 2014/53/EU, 2011/65/EU

(GB) CE-* - Declaration of conformity **RED**. We declare under our sole responsibility that this product is in conformity with the following standards or normative documents: EN IEC 62368-1, ETSI EN 301489-1, ETSI EN 301489-17, ETSI EN 300328 V2.2.2, EN 62479 in accordance with the regulations of directives 2014/53/EU, 2011/65/EU

(F) CE-* - Déclaration de conformité **RED**. Nous déclarons sous notre seule responsabilité que ce produit est en conformité avec les normes ou documents normatifs suivants: EN IEC 62368-1, ETSI EN 301489-1, ETSI EN 301489-17, ETSI EN 300328 V2.2.2, EN 62479 conformément aux réglementations des directives 2014/53/EU, 2011/65/EU

(E) CE-* - Declaración de conformidad **RED**. Declaramos bajo nuestra sola responsabilidad que este producto está en conformidad con las normas o documentos normativos siguientes: EN IEC 62368-1, ETSI EN 301489-1, ETSI EN 301489-17, ETSI EN 300328 V2.2.2, EN 62479 de acuerdo con las regulaciones de las directivas 2014/53/EU, 2011/65/EU

(I) CE-* - Dichiarazione di conformità **RED**. Dichiariamo sotto la nostra esclusiva responsabilità che questo prodotto è conforme alle seguenti norme e documenti normativi: EN IEC 62368-1, ETSI EN 301489-1, ETSI EN 301489-17, ETSI EN 300328 V2.2.2, EN 62479 conformemente alle disposizioni delle direttive 2014/53/EU, 2011/65/EU

(P) CE-* - Declaração de conformidade **RED**. Declaramos sob nossa exclusiva responsabilidade que este produto cumpre as seguintes normas ou documentos normativos: EN IEC 62368-1, ETSI EN 301489-1, ETSI EN 301489-17, ETSI EN 300328 V2.2.2, EN 62479 conforme as disposições das directivas 2014/53/EU, 2011/65/EU

(NL) CE-* - Konformiteitsverklaring **RED**. Wij verklaren en wij stellen ons er alleen voor verantwoordelijk dat dit product voldoet aan de volgende normen of normatieve documenten: EN IEC 62368-1, ETSI EN 301489-1, ETSI EN 301489-17, ETSI EN 300328 V2.2.2, EN 62479 overeenkomstig de bepalingen van de richtlijnen 2014/53/EU, 2011/65/EU

(GR) CE-* - ΔΗΛΩΣΗ ΣΥΜΜΟΡΦΩΣΗΣ **M RED**. ε αναλήψη συνολικής δηλώνουμε: ότι το πορον προϊόν συμμορφώνει με τα παρακάτω ποσούτα και με τα ηροτινηα ηου αναφέρονται στα σχετικό εγγραφα α EN IEC 62368-1, ETSI EN 301489-1, ETSI EN 301489-17, ETSI EN 300328 V2.2.2, EN 62479 σύμφωνα με τοχς κοινοισμοιου 2014/53/EU, 2011/65/EU

(S) CE-* - Konformitetsdeklaration **RED**. Vi förklarar på eget ansvar att denna produkt överensstämmer med följande normer eller normativa dokument: EN IEC 62368-1, ETSI EN 301489-1, ETSI EN 301489-17, ETSI EN 300328 V2.2.2, EN 62479 enligt bestämmelserna i direktiverna 2014/53/EU, 2011/65/EU

(DK) CE-* - Konformitetserklæring **RED**. Vi erklærer under almindeligt ansvar at dette produkt er i overensstemmelse med følgende normer eller normative dokumenter: EN IEC 62368-1, ETSI EN 301489-1, ETSI EN 301489-17, ETSI EN 300328 V2.2.2, EN 62479 i henhold til bestemmelserne i direktiverne 2014/53/EU, 2011/65/EU

(N) CE-* - Konformitetserklæring **RED**. Vi erklærer på eget ansvar at dette produkt er i overensstemmelse med følgende standarder eller standard-dokumenter: EN IEC 62368-1, ETSI EN 301489-1, ETSI EN 301489-17, ETSI EN 300328 V2.2.2, EN 62479 i henhold til bestemmelserne i direktive ne 2014/53/EU, 2011/65/EU

(FIN) CE-* - Todistus standardinmukaisuudesta **RED**. Asiaasta vastaavana todistamme täten, että tämä tuote on seuraavien standardien ja standardoimisasiakirjojen vaatimusten mukainen: EN IEC 62368-1, ETSI EN 301489-1, ETSI EN 301489-17, ETSI EN 300328 V2.2.2, EN 62479 ja vastaa säädöksiä 2014/53/EU, 2011/65/EU

(SK) CE-* - Prehľadzenie o zhode **RED**. Prehlasujeme na vlastnú zodpovednosť, že tieto produkty sú v súlade s nasledovnými normami: EN IEC 62368-1, ETSI EN 301489-1, ETSI EN 301489-17, ETSI EN 300328 V2.2.2, EN 62479 a v zhode so smernicami 2014/53/EU, 2011/65/EU

(PL) CE-* - Zgodność z dyrektywami **RED**. Świadom odpowiedzialności oświadczamy, że niniejszy produkt jest zgodny z następującymi normami lub dokumentacja normatywna: EN IEC 62368-1, ETSI EN 301489-1, ETSI EN 301489-17, ETSI EN 300328 V2.2.2, EN 62479 zgodnie z postanowieniami wytycznych 2014/53/EU, 2011/65/EU

(CZ) CE-* - Prohlášení o shodě **RED**. Prohlašujeme na vlastní zodpovědnost, že tyto produkty splňují následující normy nebo normativní listiny: EN IEC 62368-1, ETSI EN 301489-1, ETSI EN 301489-17, ETSI EN 300328 V2.2.2, EN 62479 Ve shodě se směrnicemi 2014/53/EU, 2011/65/EU

(SLO) CE-* - Izjava o skladnosti **RED**. S tem potrjujemo splošno odgovornost, da je ta izdelek narejen v skladu z navedenimi normami in standardi EN IEC 62368-1, ETSI EN 301489-1, ETSI EN 301489-17, ETSI EN 300328 V2.2.2, EN 62479 ter dolžobami in smernicami 2014/53/EU, 2011/65/EU

(HR) CE-* - Izjava o skladnosti **RED**. Pod punom odgovornošću izjavljujemo da je proizvod naveden u naslovu ovog dokumenta sukladan sa primjenjenim normama i normativnim dokumentima : EN IEC 62368-1, ETSI EN 301489-1, ETSI EN 301489-17, ETSI EN 300328 V2.2.2, EN 62479 u skladu sa odredbama preporuka 2014/53/EU, 2011/65/EU

(H) CE-* - Megfelelőségi nyilatkozat **RED**. Kéziműködtetésű elektromos kéziszerszámok. Teljes felelősséggel kijelentjük, hogy ezek a termékek a következő szabványokkal és irányelvekkel összhangban vannak: EN IEC 62368-1, ETSI EN 301489-1, ETSI EN 301489-17, ETSI EN 300328 V2.2.2, EN 62479 és megfelelnek a rendeltetés 2014/53/EU, 2011/65/EU irányelveknek.

(RO) CE-* - Declarație de conformitate **RED**. Noi declarăm pe propria răspundere că acest produs este în conformitate cu următoarele norme și documente normative: EN IEC 62368-1, ETSI EN 301489-1, ETSI EN 301489-17, ETSI EN 300328 V2.2.2, EN 62479 potrivit dispozițiilor directivelor 2014/53/EU, 2011/65/EU

Remscheid, 22.02.2022

Dipl.-Ing. Joh.-Christoph Schütz, CE-Representative

Handgeführtes batteriebetriebenes Elektrowerkzeug Typ EBS8CFM

(D) UKCA - " Konformitätserklärung. Wir erklären in alleiniger Verantwortlichkeit, dass dieses Produkt mit den folgenden Normen oder normativen Dokumenten übereinstimmt: BS EN 62841-1, BS EN ISO 12100, BS EN ISO 13857, BS EN ISO 13854, BS EN 28662-1, BS EN 61000-6-3, BS EN 61000-6-2, BS EN ISO 14118 gemäß den Bestimmungen der Richtlinien 2006/42/EG, 2014/30/EU, 2011/65/EU
RED: BS EN IEC 62368-1, ETSI EN 301489-1, ETSI EN 301489-17, ETSI EN 300328 V2.2.2, BS EN 62479 gemäß den Bestimmungen der Richtlinien 2014/53/EU, 2011/65/EU

(GB) UKCA - " Declaration of conformity. We declare under our sole responsibility that this product is in conformity with the following standards or normative documents: BS EN 62841-1, BS EN ISO 12100, BS EN ISO 13857, BS EN ISO 13854, BS EN 28662-1, BS EN 61000-6-3, BS EN 61000-6-2, BS EN ISO 14118 in accordance with the regulations of directives 2006/42/EG, 2014/30/EU, 2011/65/EU
RED: BS EN IEC 62368-1, ETSI EN 301489-1, ETSI EN 301489-17, ETSI EN 300328 V2.2.2, BS EN 62479 in accordance with the regulations of directives 2014/53/EU, 2011/65/EU

(F) UKCA - " Déclaration de conformité. Nous déclarons sous notre seule responsabilité que ce produit est en conformité avec les normes ou documents normatifs suivants: BS EN 62841-1, BS EN ISO 12100, BS EN ISO 13857, BS EN ISO 13854, BS EN 28662-1, BS EN 61000-6-3, BS EN 61000-6-2, BS EN ISO 14118 conformément aux réglementations des directives 2006/42/EG, 2014/30/EU, 2011/65/EU
RED: BS EN IEC 62368-1, ETSI EN 301489-1, ETSI EN 301489-17, ETSI EN 300328 V2.2.2, BS EN 62479 conformément aux réglementations des directives 2014/53/EU, 2011/65/EU

(E) UKCA - " Declaración de conformidad. Declaramos bajo nuestra sola responsabilidad que este producto está en conformidad con las normas o documentos normativos siguientes: BS EN 62841-1, BS EN ISO 12100, BS EN ISO 13857, BS EN ISO 13854, BS EN 28662-1, BS EN 61000-6-3, BS EN 61000-6-2, BS EN ISO 14118 de acuerdo con las regulaciones de las directivas 2006/42/EG, 2014/30/EU, 2011/65/EU
RED: BS EN IEC 62368-1, ETSI EN 301489-1, ETSI EN 301489-17, ETSI EN 300328 V2.2.2, BS EN 62479 de acuerdo con las regulaciones de las directivas 2014/53/EU, 2011/65/EU

(I) UKCA - " Dichiarazione di conformità. Dichiariamo sotto la nostra esclusiva responsabilità che questo prodotto è conforme alle seguenti norme e documenti normativi: BS EN 62841-1, BS EN ISO 12100, BS EN ISO 13857, BS EN ISO 13854, BS EN 28662-1, BS EN 61000-6-3, BS EN 61000-6-2, BS EN ISO 14118 conformemente alle disposizioni delle direttive 2006/42/EG, 2014/30/EU, 2011/65/EU
RED: BS EN IEC 62368-1, ETSI EN 301489-1, ETSI EN 301489-17, ETSI EN 300328 V2.2.2, BS EN 62479 conformemente alle disposizioni delle direttive 2014/53/EU, 2011/65/EU

(P) UKCA - " Declaração de conformidade. Declaramos sob nossa exclusiva responsabilidade que este produto cumpre as seguintes normas ou documentos normativos: BS EN 62841-1, BS EN ISO 12100, BS EN ISO 13857, BS EN ISO 13854, BS EN 28662-1, BS EN 61000-6-3, BS EN 61000-6-2, BS EN ISO 14118 conforme as disposições das directivas 2006/42/EG, 2014/30/EU, 2011/65/EU
RED: BS EN IEC 62368-1, ETSI EN 301489-1, ETSI EN 301489-17, ETSI EN 300328 V2.2.2, BS EN 62479 conforme as disposições das directivas 2014/53/EU, 2011/65/EU

(NL) UKCA - " Konformiteitsverklaring. Wij verklaren en wij stellen ons er alleen voor verantwoordelijk dat dit product voldoet aan de volgende normen of normatieve documenten: BS EN 62841-1, BS EN ISO 12100, BS EN ISO 13857, BS EN ISO 13854, BS EN 28662-1, BS EN 61000-6-3, BS EN 61000-6-2, BS EN ISO 14118 overeenkomstig de bepalingen van de richtlijnen 2006/42/EG, 2014/30/EU, 2011/65/EU
RED: BS EN IEC 62368-1, ETSI EN 301489-1, ETSI EN 301489-17, ETSI EN 300328 V2.2.2, BS EN 62479 overeenkomstig de bepalingen van de richtlijnen 2014/53/EU, 2011/65/EU

(GR) UKCA - " ΔΗΛΩΣΗ ΣΥΜΜΟΡΦΩΣΗΣ Μ: ε αναλήφθη συνολικής δηλώσεως: ότι το προϊόν συμφώνει με τα παρόντως πρότυπα και με τα πρότυπα για αναφέρονται στα σχετικά έγγραφα BS EN 62841-1, BS EN ISO 12100, BS EN ISO 13857, BS EN ISO 13854, BS EN 28662-1, BS EN 61000-6-3, BS EN 61000-6-2, BS EN ISO 14118 σύμφωνα με τους κανονισμούς 2006/42/EG, 2014/30/EU, 2011/65/EU
RED: BS EN IEC 62368-1, ETSI EN 301489-1, ETSI EN 301489-17, ETSI EN 300328 V2.2.2, BS EN 62479 σύμφωνα με τους κανονισμούς 2014/53/EU, 2011/65/EU

(S) UKCA - " Konformitetsdeklaration. Vi förklarar på eget ansvar att denna produkt överensstämmer med följande normer eller normativa dokument: BS EN 62841-1, BS EN ISO 12100, BS EN ISO 13857, BS EN ISO 13854, BS EN 28662-1, BS EN 61000-6-3, BS EN 61000-6-2, BS EN ISO 14118 enligt bestämmelserna i direktiverna 2006/42/EG, 2014/30/EU, 2011/65/EU
RED: BS EN IEC 62368-1, ETSI EN 301489-1, ETSI EN 301489-17, ETSI EN 300328 V2.2.2, BS EN 62479 enligt bestämmelserna i direktiverna 2014/53/EU, 2011/65/EU

(DK) UKCA - " Konformitetserklæring. Vi erklærer under almindeligt ansvar at dette produkt er i overensstemmelse med følgende normer eller normative dokumenter: BS EN 62841-1, BS EN ISO 12100, BS EN ISO 13857, BS EN ISO 13854, BS EN 28662-1, BS EN 61000-6-3, BS EN 61000-6-2, BS EN ISO 14118 i henhold til bestemmelserne i direktivene 2006/42/EG, 2014/30/EU, 2011/65/EU
RED: BS EN IEC 62368-1, ETSI EN 301489-1, ETSI EN 301489-17, ETSI EN 300328 V2.2.2, BS EN 62479 i henhold til bestemmelserne

*2021

i direktiverna 2014/53/EU, 2011/65/EU

(N) UKCA - " Konformitetserklæring. Vi erklærer på eget ansvar at dette produkt er i overensstemmelse med følgende standarder eller standard-dokumenter: BS EN 62841-1, BS EN ISO 12100, BS EN ISO 13857, BS EN ISO 13854, BS EN 28662-1, BS EN 61000-6-3, BS EN 61000-6-2, BS EN ISO 14118 i henhold til bestemmelserne i direktivene 2006/42/EG, 2014/30/EU, 2011/65/EU
RED: BS EN IEC 62368-1, ETSI EN 301489-1, ETSI EN 301489-17, ETSI EN 300328 V2.2.2, BS EN 62479 i henhold til bestemmelserne i direktivene 2014/53/EU, 2011/65/EU

(FIN) UKCA - " Todistus standardinmukaudesta. Asiasta vastaava todistamme täten, että tämä tuote on seuraavien standardien ja standardomaisuuksien vaatimusten mukainen: BS EN 62841-1, BS EN ISO 12100, BS EN ISO 13857, BS EN ISO 13854, BS EN 28662-1, BS EN 61000-6-3, BS EN 61000-6-2, BS EN ISO 14118 ja vastaa säädöksiä 2006/42/EG, 2014/30/EU, 2011/65/EU
RED: BS EN IEC 62368-1, ETSI EN 301489-1, ETSI EN 301489-17, ETSI EN 300328 V2.2.2, BS EN 62479 ja vastaa säädöksiä 2014/53/EU, 2011/65/EU

(SK) UKCA - " Prehlásenie o zhode. Prehlasujeme na vlastnú zodpovednosť, že tieto produkty sú v súlade s nasledujúcimi normami: BS EN 62841-1, BS EN ISO 12100, BS EN ISO 13857, BS EN ISO 13854, BS EN 28662-1, BS EN 61000-6-3, BS EN 61000-6-2, BS EN ISO 14118 a v zhode so smernicami 2006/42/EG, 2014/30/EU, 2011/65/EU
RED: BS EN IEC 62368-1, ETSI EN 301489-1, ETSI EN 301489-17, ETSI EN 300328 V2.2.2, BS EN 62479 a v zhode so smernicami 2014/53/EU, 2011/65/EU

(PL) UKCA - " Zgodność z dyrektywami UKCA. Świadomi odpowiedzialności oświadczamy, że niniejszy produkt jest zgodny z następującymi normami lub dokumentacją normatywną: BS EN 62841-1, BS EN ISO 12100, BS EN ISO 13857, BS EN ISO 13854, BS EN 28662-1, BS EN 61000-6-3, BS EN 61000-6-2, BS EN ISO 14118 zgodnie z postanowieniami wytycznych 2006/42/EG, 2014/30/EU, 2011/65/EU
RED: BS EN IEC 62368-1, ETSI EN 301489-1, ETSI EN 301489-17, ETSI EN 300328 V2.2.2, BS EN 62479 zgodnie z postanowieniami wytycznych 2014/53/EU, 2011/65/EU

(CZ) UKCA - " Prohlášení o shodě. Prohlasujeme na vlastní zodpovědnost, že tyto produkty splňují následující normy nebo normativní listiny: BS EN 62841-1, BS EN ISO 12100, BS EN ISO 13857, BS EN ISO 13854, BS EN 28662-1, BS EN 61000-6-3, BS EN 61000-6-2, BS EN ISO 14118. Ve shodě se směrnicemi 2006/42/EG, 2014/30/EU, 2011/65/EU
RED: BS EN IEC 62368-1, ETSI EN 301489-1, ETSI EN 301489-17, ETSI EN 300328 V2.2.2, BS EN 62479. Ve shodě se směrnicemi 2014/53/EU, 2011/65/EU

(SLO) UKCA - " Izjava o skladnosti. S tem potrjujemo splošno odgovornost, da je ta izdelek narejen v skladu z navedenimi normami in standardi: BS EN 62841-1, BS EN ISO 12100, BS EN ISO 13857, BS EN ISO 13854, BS EN 28662-1, BS EN 61000-6-3, BS EN 61000-6-2, BS EN ISO 14118 ter določbami in smernicami 2006/42/EG, 2014/30/EU, 2011/65/EU
RED: BS EN IEC 62368-1, ETSI EN 301489-1, ETSI EN 301489-17, ETSI EN 300328 V2.2.2, BS EN 62479 ter določbami in smernicami 2014/53/EU, 2011/65/EU

(HR) UKCA - " Izjava o skladnosti. Pod punom odgovornošću izjavljujemo da je proizvod naveden u naslovu ovog dokumenta skladan za primijenjeni normama i normativnim dokumentima: BS EN 62841-1, BS EN ISO 12100, BS EN ISO 13857, BS EN ISO 13854, BS EN 28662-1, BS EN 61000-6-3, BS EN 61000-6-2, BS EN ISO 14118 u skladu sa odredbama preporuka 2006/42/EG, 2014/30/EU, 2011/65/EU
RED: BS EN IEC 62368-1, ETSI EN 301489-1, ETSI EN 301489-17, ETSI EN 300328 V2.2.2, BS EN 62479 u skladu sa odredbama preporuka 2014/53/EU, 2011/65/EU

(H) UKCA - " Megfelelősegi nyilatkozat. Kéziműkötésű elektromos kéziszerszámok: Teljes felelősségű kijelentjük, hogy ezek a termékek a következő szabványokkal és irányelvekkel összhangban vannak: BS EN 62841-1, BS EN ISO 12100, BS EN ISO 13857, BS EN ISO 13854, BS EN 28662-1, BS EN 61000-6-3, BS EN 61000-6-2, BS EN ISO 14118; és megfelelnek a rendelkezés szerinti 2006/42/EG, 2014/30/EU, 2011/65/EU irányelveknek.
RED: BS EN IEC 62368-1, ETSI EN 301489-1, ETSI EN 301489-17, ETSI EN 300328 V2.2.2, BS EN 62479 és megfelelnek a rendelkezés szerinti 2014/53/EU, 2011/65/EU irányelveknek.

(RO) UKCA - " Declarație de conformitate. Noi declarăm pe propria răspundere că acest produs este în conformitate cu următoarele norme și documente normative: BS EN 62841-1, BS EN ISO 12100, BS EN ISO 13857, BS EN ISO 13854, BS EN 28662-1, BS EN 61000-6-3, BS EN 61000-6-2, BS EN ISO 14118; potrivit dispozițiilor directivelor 2006/42/EG, 2014/30/EU, 2011/65/EU
RED: BS EN IEC 62368-1, ETSI EN 301489-1, ETSI EN 301489-17, ETSI EN 300328 V2.2.2, BS EN 62479 potrivit dispozițiilor directivelor 2014/53/EU, 2011/65/EU

Remscheid, 22.02.2022



Joh. - Christoph Schütz
Dipl.-Ing. Joh. Christoph Schütz, CE-Representative