



www.klauke.com

MAP219CFM



Serialnumber

HPC
**Hydraulic
Pressure
Checker**

**UK
CA** Klauke UK Ltd.
NR35 1JX

EAC

IEC
62841-1

CE

50

HE.16962_E © 11/2017 R&D-2

Gustav Klauke GmbH • Auf dem Knapp 46 • D-42855 Remscheid • Telefon +49 2191 907 0 • www.klauke.com

Klauke

EMERSON

**2 Jahre
Garantie**

Wir freuen uns, dass Sie sich für ein Klauke Werkzeug entschieden haben und wünschen Ihnen viel Freude damit.

**Weltweiter
Werkzeug
Service**
Klauke ASC
Authorized Service Center

Sie haben ein Qualitätsprodukt „Made in Germany“ erworben und erhalten 2 Jahre Garantie. Diese beginnt mit dem Kaufbelegdatum.

Um lange Freude und eine einwandfreie Funktion des Werkzeuges sicherzustellen, muss das Gerät spätestens beim Erreichen von 10.000 Arbeitsvorgängen oder nach 3 Jahren durch ein Autorisiertes Service Center (ASC) gewartet werden. Wird das Wartungsintervall von 10.000 Arbeitsvorgängen nicht eingehalten, erlischt der Garantieanspruch.

Im Rahmen dieser Wartung werden verschlissene Teile ersetzt und sicherheitsrelevante Teile geprüft und ggf. vorbeugend ersetzt.

Darüber hinaus empfehlen wir das Gerät jährlich zur Überprüfung an das zuständige ASC einzusenden.

Für Fragen rund um unseren Werkzeugservice stehen wir Ihnen unter folgenden Rufnummern persönlich zur Verfügung:

Technik +492332709544

Reparaturen / Leihgeräte +492332709540



Ihr Klauke-Service Team



Die Bluetooth®-Wortmarke und das Bluetooth®-Symbol sind eingetragene Warenzeichen der Bluetooth SIG, Inc. und jegliche Verwendung durch Gustav Klauke GmbH ist lizenziert.

**2 years
Warranty**

Thank you for choosing a Klauke tool. We hope it gives you lots of pleasure.

**World wide
Tool
Service**
Klauke ASC
Authorized Service Center

You have purchased a quality product „Made in Germany“, which is covered by a 2 year warranty. The warranty commences from the purchase receipt date.

To ensure lasting enjoyment and a flawless tool function, the product must be serviced by an Authorised Service Center (ASC) after 10,000 operations or after 3 years. Should the service Interval exceed 10.000 cycles the warranty claim is void.

The Service includes predictive maintenance in which worn-out parts will be replaced and safety relevant parts checked/replaced.

We recommend to have the tools checked yearly through an Authorized Service Center (ASC).

For questions about our tool service we are personally available under the following telephone numbers:

Technical Support +492332709544

Repairs / Loaner tools +492332709540



Your Klauke-Service Team



The Bluetooth® word mark and Bluetooth® symbol are registered trademarks of Bluetooth SIG, Inc. and any use by Gustav Klauke GmbH is licensed.



MAP219CFM

Klauke



⚠ WARNING

Read all safety warnings, instructions, illustrations and specifications provided with this power tool. Failure to follow all instructions listed below may result in electric shock, fire and/or serious injury. Save all warnings and instructions for future reference.

For US and Canada only
 FCC ID: RFR-890 • IC: 4957A-890
 Model: CFM
 This device complies with Part 15 of the FCC Rules and with Industry Canada license-exempt RSS standard(s). Operation is subject to the following two conditions: (1) this device may not cause harmful interference, and (2) this device must accept any interference received, including interference that may cause undesired operation. HE 8095

batch# e.g. 304711
 datecode e.g. X = 2027; N = Jan.
 consecutive# e.g. „142“ = tool # 142
 datecode

Year	Code	Month	Code	Month	Code
2022	R	Jan.	N	July	V
2023	S	Feb.	P	Aug.	W
2024	T	Mar.	Q	Sept.	X
2025	V	Apr.	R	Oct.	Y
2026	W	May	S	Nov.	Z
2027	X	June	T	Dec.	1

Klauke
 Auf dem Krapp 46
 D-42855
 Remscheid

304711
 XN
 142

optional:
 BL1840 (RAL40)



Abb. ähnlich / pic. similar
 HE.16962_E © 11/2017





MAP219CFM

Klauke

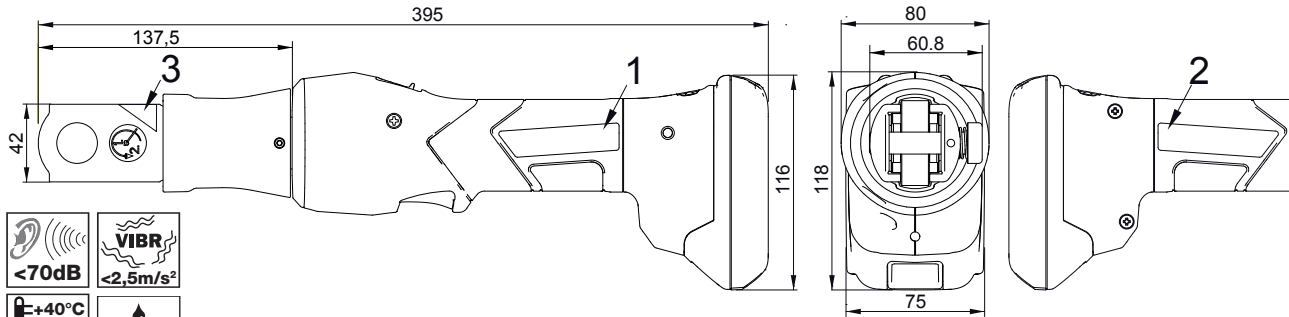

 <70dB	 VIBR <2,5m/s²
 +40°C -10°C	 BIO
 2,0 kg	 19 kN
IP 44	

1 **Klauke[®] mini**
Gustav Klauke GmbH
Auf dem Knapp 46 • D-42855 Remscheid

HE 16962_E

2 **CE** **UK** **CA** **MAP219CFM**
made by **Klauke**
Pressing tool • 19 kN • 18V ---
For use only with Klauke RALK1box and Makita BL1box battery series

HE 16965_D



Abb. ähnlich / pic. similar
HE.16962_E © 11/2017





Scope of accessories

Typ	SBMX	UWMX	WE (MP32)

Applications

Stainless steel, steel	max. 35 mm *
Copper, copper alloys	max. 35 mm *
Multi-layer composite pipe/PEX pipe	max. 40 mm*
* These values are system-related Please contact your system supplier for binding information	

Achtung

Beachten Sie die Einhaltung der zum Zeitpunkt der Installation/Verlegung allgemein gültigen Installations/Verlegeanleitungen und der Betriebs-, Bedienungs- und Wartungsanleitungen der Firma KLAUKE einschließlich deren schriftlichen Angaben zum Verwendungsbereich sowie Beachtung der Hinweise auf die Installations- und Verlegerichtlinien des Systemherstellers.

Bestimmungsgemäße Installation/Verlegung unter Einhaltung der zum Zeitpunkt der Installation/Verlegung geltenden anerkannten Regeln der Technik sowie aller einschlägigen Gesetze und Verordnungen sind einzuhalten.

Diese Angaben sind systemabhängig. Für verbindliche Informationen wenden Sie sich bitte an Ihren Systemanbieter.

Attention

Please follow the general installation/mapping instructions as well as the operation and Service instructions of the company Gustav Klauke including the respective written notes on the application range as well as installation and mapping instructions of the system supplier.

Please observe the current generally accepted technical rules as well as all applicable laws and directives for the intended installation/mapping.

These values are system-related. Please contact your system supplier for binding information.



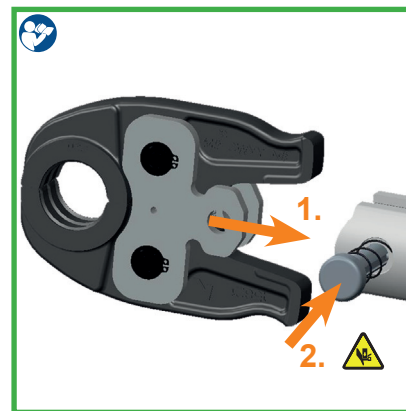
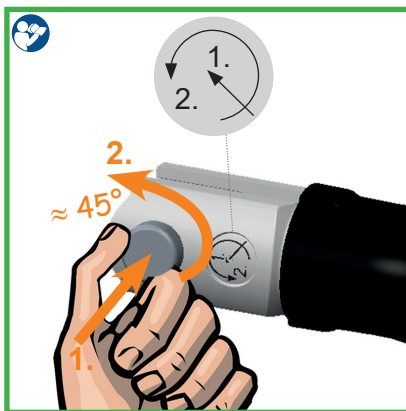
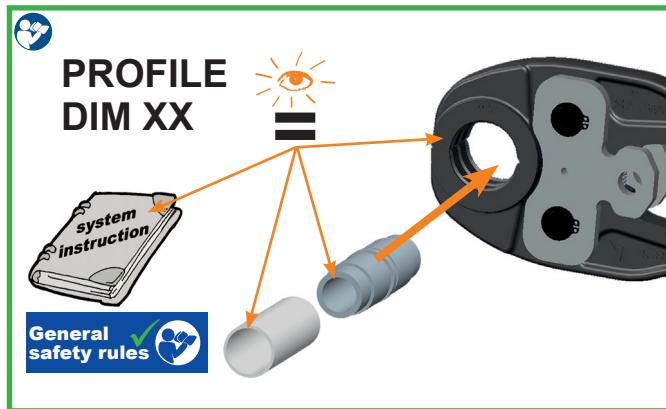
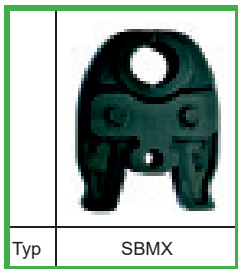



MAP219CFM

Klauke



Abb. ähnlich / pic. similar
HE.16962_E © 11/2017

WORK



SERVICE

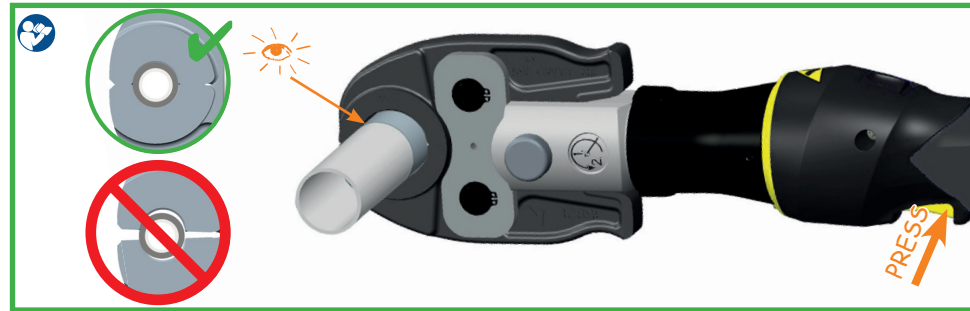
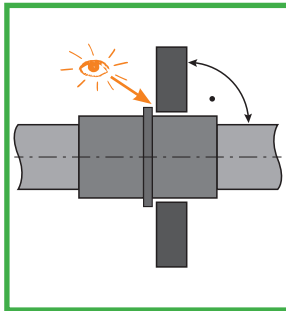
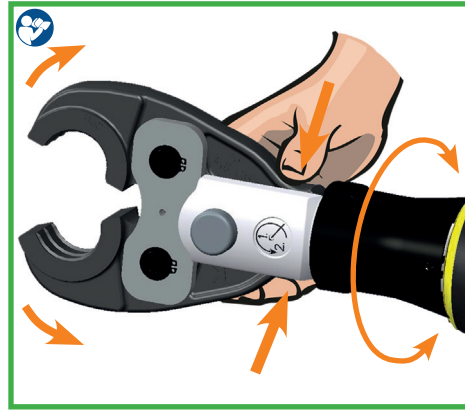

DON'T DO



General safety rules





MAP219CFM

Klauke

	UWMX
	WE (MP32)



Abb. ähnlich / pic. similar
HE.16962_E © 11/2017

WORK



SERVICE

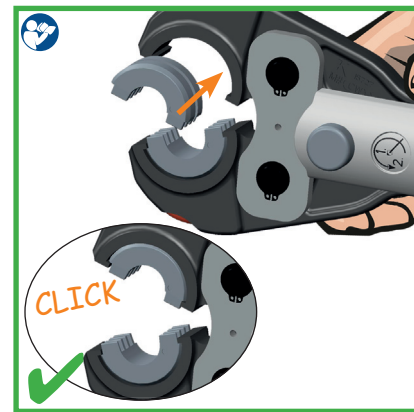
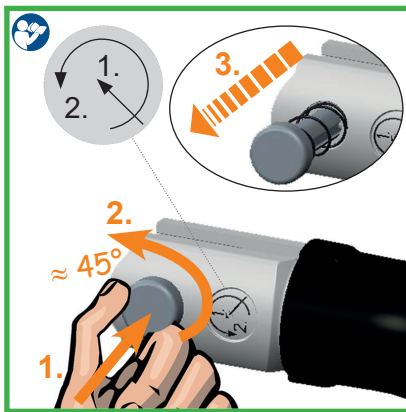
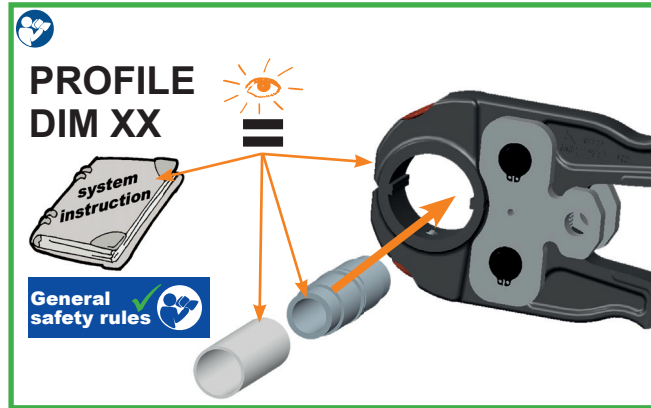

DON'T DO



General safety rules





Abb. ähnlich / pic. similar
HE.16962_E © 11/2017

WORK



SERVICE

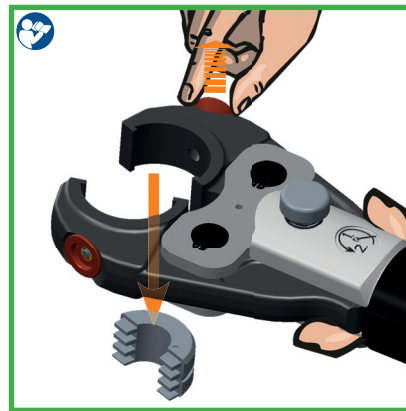
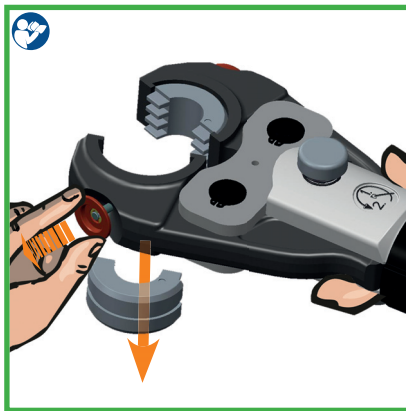
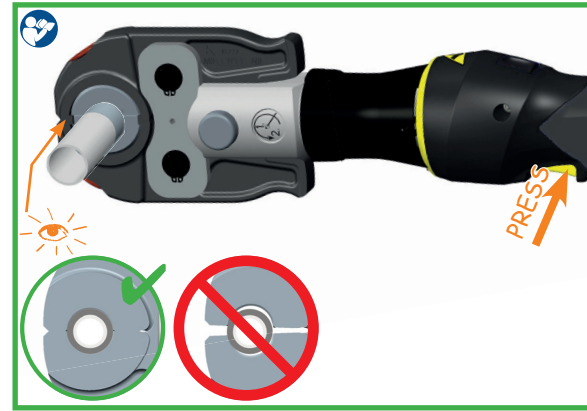
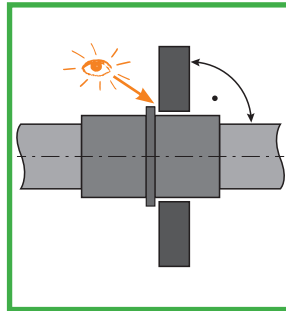

DON'T DO



General safety rules





MAP219CFM

Klauke



Abb. ähnlich / pic. similar
HE.16962_E © 11/2017



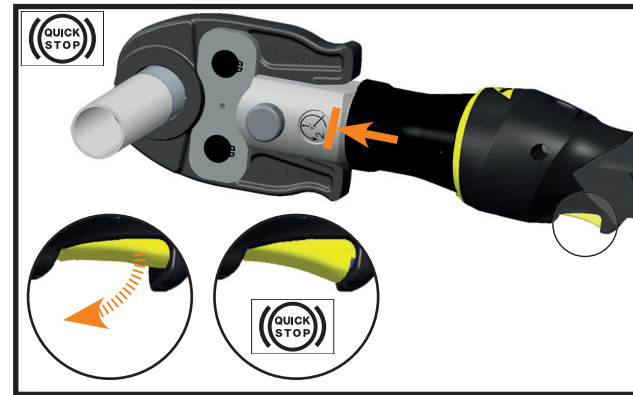
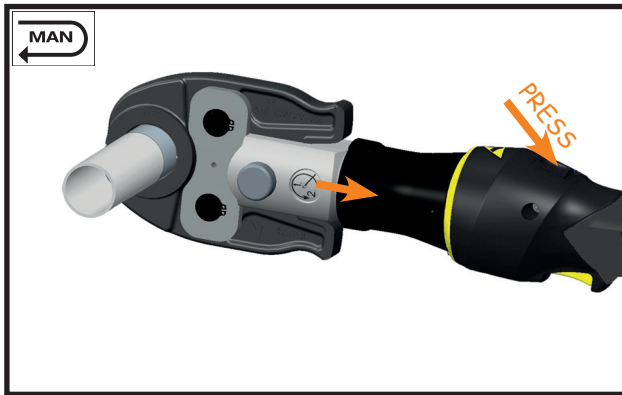
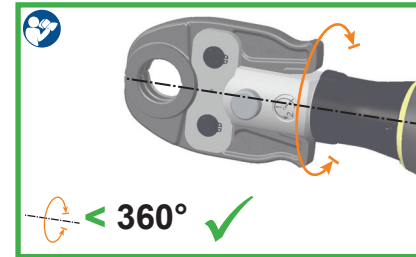
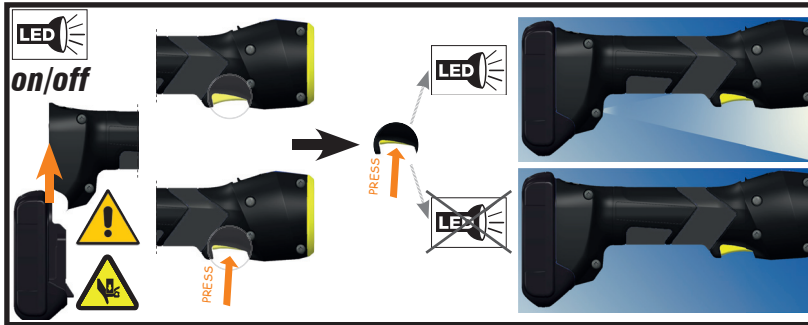

MAP219CFM

Klauke

3 years or 10.000 operations

Klauke ASC
Authorised Service Center

2 years Warranty
World wide Tool Service
Klauke ASC

OLD PART REPLACEMENT SAFETY NEW

once a year

Klauke ASC
Authorised Service Center

1. OIL

2.

3.

Daily

WEEE 2012/19/EU

Klauke-WEEE-Abholung@Emerson.com

2 years Warranty
World wide Tool Service
Klauke ASC

ACHTUNG! Bei Beschädigung des Garantiesiegels ist der Garantieverlust zu erwarten.
ATTENTION! If broken seal it loses Warranty

2 years Warranty
World wide Tool Service
Klauke ASC

Klauke ASC
Authorised Service Center

Klauke

Power-Handy und Zubehör
für alle Arten von Metallbearbeitungen

Grease
Moose

OIL

Abb. ähnlich / pic. similar
HE.16962_E © 11/2017

WORK

SERVICE

DON'T DO

DON'T DO

General safety rules



1							
2							
	ERROR CODE: ****	Error code	*1				
3a		BT P 3 bar P 3 bar	*2	Bluetooth (if connected) Battery charging level Current pressure Pressure max.			
3b		bar / psi	3 sec.	to change: bar / psi			
3c		bar / psi					
3b		kN / lbf	3 sec.	to change: kN / lbf			
3d		BT F 74 lbf F 369 lbf					
4a		USER 3: RD3 Einfachclick	Single-Click	4b		USER SELECT: RD3 Einfachclick	Single-Click select
4c		USER SELECT 3: RD3 Doppelclick	Double-Click enter menu	4d		USER SELECT: RD3 Doppelclick	Double-Click confirmed
5		NEXT SERVICE: 9826 0Ps	Cycles (until next service)	6		TOTAL: t = 0.07 h Q = 21.12 Ah n = 174	Since manufacturing: operating hours Capacity # crimps
7		RETURN					

- *1 Error codes/ Fehlermeldungen:
- 1 Overcurrent fuse
 - 2 Overcurrent comparator
 - 3 Overheat board
 - 4 Overheat battery
 - 5 Battery empty, operation stop
 - 6 Faulty crimp motor in operation
 - 7 Faulty crimp motor not in operation
 - 8 Low battery
 - 9 Battery empty
 - 10 RTC battery low
 - 12 Service necessary
 - 13 RTC not found
 - 14 BT unit not found
 - 15 Mobile unit not found
 - 16 Pressure sensor not found
 - 17 Burst pressure exceeded
 - 18 Battery temperature too low
 - 19 Battery reserves
 - 20 Overcurrent fuse (I)
 - 21 Remote Control Battery Low!
 - 22 Service necessary SAST1
 - 23 Service necessary SAST2
 - 24 Service necessary SAST3
 - 25 Remote mode: tool trigger not actuated*
 - 27 Overheat motor
 - 28 Service necessary: Pressure low
 - 29 Service necessary: Pressure high
- 1 Überstromsicherung
 - 2 Überstromsicherung durch Komparator
 - 3 Boardtemperatur zu hoch
 - 4 Akkutemperatur zu hoch
 - 5 Akkuspannung zu gering
 - 6 Fehlpressung bei laufendem Motor
 - 7 Fehlpressung bei stehendem Motor
 - 8 Niedrige Akkuspannung
 - 9 Akku leer
 - 10 RTC-Batterie leer
 - 12 Service nötig
 - 13 RTC nicht verfügbar
 - 14 BT-Modul nicht verfügbar
 - 15 Modul nicht verfügbar
 - 16 Drucksensor nicht verfügbar
 - 17 Barstdruck überschritten
 - 18 Akkutemperatur zu gering
 - 19 Batteriereserven zu gering
 - 20 Überstromsicherung (I)
 - 21 Fernbedienung-Batterie schwach*
 - 22 Service notwendig SAST1
 - 23 Service notwendig SAST2
 - 24 Service notwendig SAST3
 - 25 Remote-Modus: WZ-Taster nicht betätigt*
 - 27 Motortemperatur zu hoch
 - 28 Service notwendig: Druck niedrig
 - 29 Service notwendig: Druck hoch
- * remote control tools only/
nur bei fernbedienungs-fähigen Werkzeugen

*2 (2Hz)





MAP219CFM

Klauke



Klauke i-press® Software

▶ www.klauke.com/connectivity



Klauke i-press® App

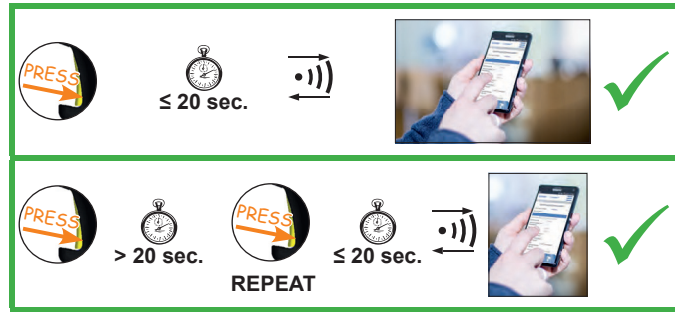

For US and Canada only

Le présent appareil est conforme aux CNR d'Industrie Canada applicables aux appareils radio exempts de licence. L'exploitation est autorisée aux deux conditions suivantes:

- (1) l'appareil ne doit pas produire de brouillage, et
- (2) l'utilisateur de l'appareil doit accepter tout brouillage radioélectrique subi, même si le brouillage est susceptible d'en compromettre le fonctionnement.

NOTICE:





Changes or modifications made to this equipment not expressly approved by Klauke may void the FCC authorization to operate this equipment.









MAP219CFM

Use tool only with 18 V Makita battery







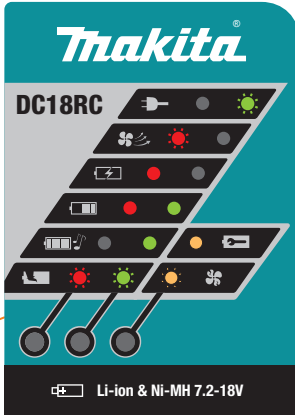





<p>BL1850(B) 45 min. RAL4</p> <p>BL1840(B) 36 min. RAL40</p> <p>BL1830(B) 22 min. RAL2</p> <p>BL1815 15 min. RAL1</p> <p>10 - 40°C</p>	
--	--

Alle Bedienungsanleitungen auch unter www.klauke.de abrufbar
All manuals are also available on www.Klauke.com













Abb. ähnlich / pic. similar
HE.16962_E © 11/2017







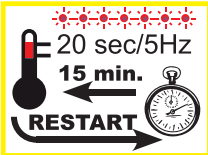





			<p>Wann/When/Quand/Quando/ cuándo/Wanneer/Когда/это происходит/Kiedy/quando</p>	<p>Warum/Why/Pourquoi/Porquê/ ¿por qué?/Waarom/Причина/ Dlaczego/Perché</p>
 20 sec			<p>nach Arbeitsvorgang after working cycle après opération de travail Después del proceso de trabajo após o processo de trabalho na bedrijfscyclus после цикла опрессовки po zakończeniu pracy dopo il processo di lavoro</p>	
 20 sec/2Hz			<p>nach Arbeitsvorgang after working cycle après opération de travail Después del proceso de trabajo após o processo de trabalho na bedrijfscyclus после цикла опрессовки po zakończeniu pracy dopo il processo di lavoro</p>	 <p>Klauke ASC Authorized Service Center</p>
 20 sec/5Hz			<p>während der Übertemperatur while exceeding the temp. limit pendant surchauffe en caso de temperatura excesiva durante a temperatura excessiva tijdens te hoge temperatuur при высокой температуре внутри корпуса przy przegrzaniu superando il limite di temperatura</p>	<p>Werkzeug zu heiß Unit too hot outil surchauffé Herramienta demasiado caliente ferramenta demasiado quente gereedschap te heet Перегрев инструмента urządzenie za gorące Utensile troppo caldo</p> 





SERVICE 	LED 		Wann/When/Quand/Quando/ cuándo/Wanneer/Когда/это происходит/Kiedy/quando	Warum/Why/Pourquoi/Porquê/ ¿por qué?/Waarom/Причина/ Dlaczego/Perché
 1 x	 1 x		nach Arbeitsvorgang after working cycle après opération de travail Después del proceso de trabajo após o processo de trabalho na bedrijfscyclus после цикла опрессовки po zakończeniu pracy dopo il processo di lavoro	Fehler: der notwendige Pressdruck wurde nicht erreicht. Es handelt sich um eine manuelle Unterbrechung der Pressung bei stehendem Motor. Error: the required pressure has not been reached. The operator has interrupted the pressing cycle manually while the motor was not running. ERREUR: Pression necessaire pas atteinte. Il s'agit d'une interruption manuelle de la sertissage au moteur arrêté. Error: No se ha alcanzado la presión necesaria o el operador ha interrumpido el ciclo a mano mientras el motor ha parado. Falha: a pressão de prensagem necessária não foi alcançada. Trata-se de uma interrupção manual da prensagem com o motor parado. Foutmelding: De benodigde persdruk wordt niet bereikt. De gebruiker heeft de verkrimping handmatig stopgezet aangezien de motor niet actief is. Ошибка: не было достигнуто требуемое усилие опрессовки или оператор прервал процесс опрессовки вручную, когда двигатель остановился. Błąd: konieczne ciśnienie nie zostało osiągnięte. Użytkownik przerwał cykl pracy ręcznie w chwili, gdy silnik nie był włączony Errore: la pressione richiesta non è stata raggiunta. L'operatore ha interrotto manualmente il ciclo di pressatura mentre il motore non è in funzione.
 3 x	 3 x		nach Arbeitsvorgang after working cycle après opération de travail Después del proceso de trabajo após o processo de trabalho na bedrijfscyclus после цикла опрессовки po zakończeniu pracy dopo il processo di lavoro	Schwerwiegender Fehler: Pressdruck wurde bei laufendem Motor nicht erreicht. Serious Error: The pressure has not been reached while the motor was running. Erreur Grave: Pression pas atteinte au moteur courant. Error grave: No se ha alcanzado presión mientras el motor estaba en marcha Falha grave: a pressão de prensagem não foi alcançada com o motor em funcionamento. Urgente foutmelding: De persdruk werd bij een werkende motor niet bereikt. Серьезная ошибка: не было достигнуто требуемое усилие опрессовки во время работы двигателя Poważny błąd: konieczne ciśnienie nie zostało osiągnięte podczas pracy silnika Errore grave: la pressione non è stata raggiunta mentre il motore è in funzione.

Handgeführtes batteriebetriebenes Elektrowerkzeug Typ MAP219CFM

Klauke

(D) CE-* - Konformitätserklärung. Wir erklären in alleiniger Verantwortlichkeit, daß dieses Produkt mit den folgenden Normen oder normativen Dokumenten übereinstimmt: EN 62841-1, EN ISO 12100, EN ISO 13857, EN ISO 13854, EN 28662-1, EN 61000-6-3, EN 61000-6-2, EN 60529, EN ISO 14118 gemäß den Bestimmungen der Richtlinien 2006/42/EG, 2014/30/EU, 2011/65/EU

(GB) CE-* - Declaration of conformity. We declare under our sole responsibility that this product is in conformity with the following standards or normative documents: EN 62841-1, EN ISO 12100, EN ISO 13857, EN ISO 13854, EN 28662-1, EN 61000-6-3, EN 61000-6-2, EN 60529, EN ISO 14118 in accordance with the regulations of directives 2006/42/EG, 2014/30/EU, 2011/65/EU

(F) CE-* - Déclaration de conformité. Nous déclarons sous notre seule responsabilité que ce produit est en conformité avec les normes ou documents normatifs suivants: EN 62841-1, EN ISO 12100, EN ISO 13857, EN ISO 13854, EN 28662-1, EN 61000-6-3, EN 61000-6-2, EN 60529, EN ISO 14118 conformément aux réglementations des directives 2006/42/EG, 2014/30/EU, 2011/65/EU

(E) CE-* - Declaración de conformidad. Declaramos bajo nuestra sola responsabilidad que este producto está en conformidad con las normas o documentos normativos siguientes: EN 62841-1, EN ISO 12100, EN ISO 13857, EN ISO 13854, EN 28662-1, EN 61000-6-3, EN 61000-6-2, EN 60529, EN ISO 14118 de acuerdo con las regulaciones de las directivas 2006/42/EG, 2014/30/EU, 2011/65/EU

(I) CE-* - Dichiarazione di conformità. Dichiariamo sotto la nostra esclusiva responsabilità che questo prodotto è conforme alle seguenti norme e documenti normativi: EN 62841-1, EN ISO 12100, EN ISO 13857, EN ISO 13854, EN 28662-1, EN 61000-6-3, EN 61000-6-2, EN 60529, EN ISO 14118 conformemente alle disposizioni delle direttive 2006/42/EG, 2014/30/EU, 2011/65/EU

(P) CE-* - Declaração de conformidade. Declaramos sob nossa exclusiva responsabilidade que este produto cumpre as seguintes normas ou documentos normativos: EN 62841-1, EN ISO 12100, EN ISO 13857, EN ISO 13854, EN 28662-1, EN 61000-6-3, EN 61000-6-2, EN 60529, EN ISO 14118 conforme as disposições das directivas 2006/42/EG, 2014/30/EU, 2011/65/EU

(NL) CE-* - Konformiteitsverklaring. Wij verklaren en wij stellen ons er alleen voor verantwoordelijk dat dit product voldoet aan de volgende normen of normatieve documenten: EN 62841-1, EN ISO 12100, EN ISO 13857, EN ISO 13854, EN 28662-1, EN 61000-6-3, EN 61000-6-2, EN 60529, EN ISO 14118 overeenkomstig de bepalingen van de richtlijnen 2006/42/EG, 2014/30/EU, 2011/65/EU

(GR) CE-* - ΔΗΛΩΣΗ ΣΥΜΜΟΡΦΩΣΗΣ Με αναληψη συνολικης δηλωνομε οτι το πορον προιον συμφωρει με τα παρακατω ποστυπα και με τα προτυπα ηου αναφερονται στα σχετικα εγγραφα EN 62841-1, EN ISO 12100, EN ISO 13857, EN ISO 13854, EN 28662-1, EN 61000-6-3, EN 61000-6-2, EN 60529, EN ISO 14118 συμφωνα με τοχς κοινοισμους 2006/42/EG, 2014/30/EU, 2011/65/EU

(S) CE-* - Konformitetsdeklaration. Vi förklarar på eget ansvar att denna produkt överensstämmer med följande normer eller normativa dokument: EN 62841-1, EN ISO 12100, EN ISO 13857, EN ISO 13854, EN 28662-1, EN 61000-6-3, EN 61000-6-2, EN 60529, EN ISO 14118 enligt bestämmelserna i direktiverna 2006/42/EG, 2014/30/EU, 2011/65/EU

(DK) CE-* - Konformitetserklæring. Vi erklærer under almindeligt ansvar at dette produkt er i overensstemmelse med følgende normer eller normative dokumenter: EN 62841-1, EN ISO 12100, EN ISO 13857, EN ISO 13854, EN 28662-1, EN 61000-6-3, EN 61000-6-2, EN 60529, EN ISO 14118 i henhold til bestemmelserne i direktiverne 2006/42/EØF, 2014/30/EU, 2011/65/EU

(N) CE-* - Konformitetserklæring. Vi erklærer på eget ansvarlighet at dette produkt er i overensstemmelse med følgende standarder eller standard-dokumenter: EN 62841-1, EN ISO 12100, EN ISO 13857, EN ISO 13854, EN 28662-1, EN 61000-6-3, EN 61000-6-2, EN 60529, EN ISO 14118 i henhold til bestemmelserne i direktivene 2006/42/EØF, 2014/30/EU, 2011/65/EU

(FIN) CE-* - Todistus standardinmukaisuudesta. Asiaa vastaavana todistamme täten, että tämä tuote on seuraavien standardien ja standardoimisasiakirjojen vaatimusten mukainen: EN 62841-1, EN ISO 12100, EN ISO 13857, EN ISO 13854, EN 28662-1, EN 61000-6-3, EN 61000-6-2, EN 60529, EN ISO 14118 ja vastaa säädöksiä 2006/42/EG, 2014/30/EU, 2011/65/EU

(SK) CE-* - Prehlásenie o zhode. Prehlasujeme na vlastnú zodpovednosť, že tieto produkty sú v súlade s nasledovnými normami: EN 62841-1, EN ISO 12100, EN ISO 13857, EN ISO 13854, EN 28662-1, EN 61000-6-3, EN 61000-6-2, EN 60529, EN ISO 14118 a v zhode so smerniciami 2006/42/EG, 2014/30/EU, 2011/65/EU

(PL) CE-* - Zgodność z dyrektywami CE. Świadomi odpowiedzialności oświadczamy, że niniejszy produkt jest zgodny z następującymi normami lub dokumentacją normatywną: EN 62841-1, EN ISO 12100, EN ISO 13857, EN ISO 13854, EN 28662-1, EN 61000-6-3, EN 61000-6-2, EN 60529, EN ISO 14118 zgodnie z postanowieniami wytycznych 2006/42/EG, 2014/30/EU, 2011/65/EU

(CZ) CE-* - Prohlášení o shodě. Prohlasujeme na vlastní zodpovědnost, že tyto produkty splňují následující normy nebo normativní listiny: EN 62841-1, EN ISO 12100, EN ISO 13857, EN ISO 13854, EN 28662-1, EN 61000-6-3, EN 61000-6-2, EN 60529, EN ISO 14118; Ve shodě se směrnicemi 2006/42/EG, 2014/30/EU, 2011/65/EU

(SLO) CE-* - Izjava o skladnosti. S tem potrjujemo splošno odgovornost, da je ta izdelek narejen v skladu z navedenimi normami in standardi: EN 62841-1, EN ISO 12100, EN ISO 13857, EN ISO 13854, EN 28662-1, EN 61000-6-3, EN 61000-6-2, EN 60529, EN ISO 14118 ter določbami in smernicami 2006/42/EG, 2014/30/EU, 2011/65/EU

(HR) CE-* - Izjava o skladnosti. Pod punom odgovornošću izjavljujemo da je proizvod naveden u naslovu ovog dokumenta sukladan sa primijenjenim normama i normativnim dokumentima : EN 62841-1, EN ISO 12100, EN ISO 13857, EN ISO 13854, EN 28662-1, EN 61000-6-3, EN 61000-6-2, EN 60529, EN ISO 14118 u skladu sa odredbama preporuka 2006/42/EG, 2014/30/EU, 2011/65/EU

(H) CE-* - Megfelelősségi nyilatkozat. Kéziműködtetésű elektromos kéziszerszámok: Teljes felelősséggel kijelentjük, hogy ezek a termékek a következő szabványokkal és irányelvekkel összhangban vannak: EN 62841-1, EN ISO 12100, EN ISO 13857, EN ISO 13854, EN 28662-1, EN 61000-6-3, EN 61000-6-2, EN 60529, EN ISO 14118; és megfelelnek a rendeltetés szerinti 2006/42/EG, 2014/30/EU, 2011/65/EU irányelveknek.

(RO) CE-* - Declarație de conformitate. Noi declarăm pe propria răspundere că acest produs este în conformitate cu următoarele norme și documente normative: EN 62841-1, EN ISO 12100, EN ISO 13857, EN ISO 13854, EN 28662-1, EN 61000-6-3, EN 61000-6-2, EN 60529, EN ISO 14118; potrivit dispozițiilor directivelor 2006/42/EG, 2014/30/EU, 2011/65/EU

Remscheid, 22.02.2022



Joh. - Christoph Schütz

Dipl.-Ing. Joh.-Christoph Schütz, CE-Representative

*2017

Handgeführtes batteriebetriebenes Elektrowerkzeug Typ MAP219CFM

Klauke

(D) CE - Konformitätserklärung **RED**. Wir erklären in alleiniger Verantwortlichkeit, daß dieses Produkt mit den folgenden Normen oder normativen Dokumenten übereinstimmt: EN IEC 62368-1, ETSI EN 301489-1, ETSI EN 301489-17, ETSI EN 300328 V2.2.2, EN 62479 gemäß den Bestimmungen der Richtlinien 2014/53/EU, 2011/65/EU

(GB) CE - Declaration of conformity **RED**. We declare under our sole responsibility that this product is in conformity with the following standards or normative documents: EN IEC 62368-1, ETSI EN 301489-1, ETSI EN 301489-17, ETSI EN 300328 V2.2.2, EN 62479 in accordance with the regulations of directives 2014/53/EU, 2011/65/EU

(F) CE - Déclaration de conformité **RED**. Nous déclarons sous notre seule responsabilité que ce produit est en conformité avec les normes ou documents normatifs suivants: EN IEC 62368-1, ETSI EN 301489-1, ETSI EN 301489-17, ETSI EN 300328 V2.2.2, EN 62479 conformément aux réglementations des directives 2014/53/EU, 2011/65/EU

(E) CE - Declaración de conformidad **RED**. Declaramos bajo nuestra sola responsabilidad que este producto está en conformidad con las normas o documentos normativos siguientes: EN IEC 62368-1, ETSI EN 301489-1, ETSI EN 301489-17, ETSI EN 300328 V2.2.2, EN 62479 de acuerdo con las regulaciones de las directivas 2014/53/EU, 2011/65/EU

(I) CE - Dichiarazione di conformità **RED**. Dichiariamo sotto la nostra esclusiva responsabilità che questo prodotto è conforme alle seguenti norme e documenti normativi: EN IEC 62368-1, ETSI EN 301489-1, ETSI EN 301489-17, ETSI EN 300328 V2.2.2, EN 62479 conformemente alle disposizioni delle direttive 2014/53/EU, 2011/65/EU

(P) CE - Declaração de conformidade **RED**. Declaramos sob nossa exclusiva responsabilidade que este produto cumpre as seguintes normas ou documentos normativos: EN IEC 62368-1, ETSI EN 301489-1, ETSI EN 301489-17, ETSI EN 300328 V2.2.2, EN 62479 conforme as disposições das directivas 2014/53/EU, 2011/65/EU

(NL) CE - Konformiteitsverklaring **RED**. Wij verklaren en wij stellen ons er alleen voor verantwoordelijk dat dit product voldoet aan de volgende normen of normatieve documenten: EN IEC 62368-1, ETSI EN 301489-1, ETSI EN 301489-17, ETSI EN 300328 V2.2.2, EN 62479 overeenkomstig de bepalingen van de richtlijnen 2014/53/EU, 2011/65/EU

(GR) CE - ΔΗΛΩΣΗ ΣΥΜΜΟΡΦΩΣΗΣ **M RED**. ε αναλήψη συνολικής δηλώνουμε: ότι το πορον προϊόν συμφορει με τα παρακατω ποοντα και με τα ηροτινη ηου αναφοροντα στα σχετικο εγγραφα α EN IEC 62368-1, ETSI EN 301489-1, ETSI EN 301489-17, ETSI EN 300328 V2.2.2, EN 62479 συμφορα με τοχς κοινοισμοιου 2014/53/EU, 2011/65/EU

(S) CE - Konformitetsdeklaration **RED**. Vi förklarar på eget ansvar att denna produkt överensstämmer med följande normer eller normativa dokument: EN IEC 62368-1, ETSI EN 301489-1, ETSI EN 301489-17, ETSI EN 300328 V2.2.2, EN 62479 enligt bestämmelserna i direktiverna 2014/53/EU, 2011/65/EU

(DK) CE - Konformitetserklæring **RED**. Vi erklærer under almindeligt ansvar at dette produkt er i overensstemmelse med følgende normer eller normative dokumenter: EN IEC 62368-1, ETSI EN 301489-1, ETSI EN 301489-17, ETSI EN 300328 V2.2.2, EN 62479 i henhold til bestemmelserne i direktivene 2014/53/EU, 2011/65/EU

(N) CE - Konformitetserklæring **RED**. Vi erklærer på eget ansvar at dette produkt er i overensstemmelse med følgende standarder eller standard-dokumenter: EN IEC 62368-1, ETSI EN 301489-1, ETSI EN 301489-17, ETSI EN 300328 V2.2.2, EN 62479 i henhold til bestemmelserne i direktive ne 2014/53/EU, 2011/65/EU

(FIN) CE - Todistus standardinmukaisuudesta **RED**. Asiaasta vastaavana todistamme täten, että tämä tuote on seuraavien standardien ja standardoimisasiakirjojen vaatimusten mukainen: EN IEC 62368-1, ETSI EN 301489-1, ETSI EN 301489-17, ETSI EN 300328 V2.2.2, EN 62479 ja vastaa säädöksiä 2014/53/EU, 2011/65/EU

(SK) CE - Prehľadzenie o zhode **RED**. Prehlasujeme na vlastnú zodpovednosť, že tieto produkty sú v súlade s nasledovnými normami: EN IEC 62368-1, ETSI EN 301489-1, ETSI EN 301489-17, ETSI EN 300328 V2.2.2, EN 62479 a v zhode so smernicami 2014/53/EU, 2011/65/EU

(PL) CE - Zgodnosc z dyrektywami **RED**. Swiadomiy odpowiedzialnosci oswiadczyamy, ze niniejszy produkt jest zgodny z nastepujacymi normami lub dokumentacja normatywna: EN IEC 62368-1, ETSI EN 301489-1, ETSI EN 301489-17, ETSI EN 300328 V2.2.2, EN 62479 zgodnie z postanowieniami wytycznych 2014/53/EU, 2011/65/EU

(CZ) CE - Prohlášení o shodě **RED**. Prohlasujeme na vlastní zodpovednost, ze tyto produkty splnuji nasledujici normy nebo normativni listiny: EN IEC 62368-1, ETSI EN 301489-1, ETSI EN 301489-17, ETSI EN 300328 V2.2.2, EN 62479 Ve shode se smernicemi 2014/53/EU, 2011/65/EU

(SLO) CE - Izjava o skladnosti **RED**. S tem potrjujemo splošno odgovornost, da je ta izdelek narejen v skladu z navedenimi normami in standardi EN IEC 62368-1, ETSI EN 301489-1, ETSI EN 301489-17, ETSI EN 300328 V2.2.2, EN 62479 ter dolobčami in smernicami 2014/53/EU, 2011/65/EU

(HR) CE - Izjava o skladnosti **RED**. Pod punom odgovornošću izjavljujemo da je proizvod naveden u naslovu ovog dokumenta sukladan sa primjenjenim normama i normativnim dokumentima : EN IEC 62368-1, ETSI EN 301489-1, ETSI EN 301489-17, ETSI EN 300328 V2.2.2, EN 62479 u skladu sa odredbama preporuka 2014/53/EU, 2011/65/EU

(H) CE - Megfelelőségi nyilatkozat **RED**. Kéziműködtetésű elektromos kéziszerszámok. Teljes felelősséggel kijelentjük, hogy ezek a termékek a következő szabványokkal és irányelvekkel összhangban vannak: EN IEC 62368-1, ETSI EN 301489-1, ETSI EN 301489-17, ETSI EN 300328 V2.2.2, EN 62479 és megfelelnek a rendeltetés 2014/53/EU, 2011/65/EU irányelveknek.

(RO) CE - Declarație de conformitate **RED**. Noi declarăm pe propria răspundere că acest produs este în conformitate cu următoarele norme și documente normative: EN IEC 62368-1, ETSI EN 301489-1, ETSI EN 301489-17, ETSI EN 300328 V2.2.2, EN 62479 potrivit dispozițiilor directivelor 2014/53/EU, 2011/65/EU

Remscheid, 22.02.2022

CE 
Dipl.-Ing. Joh.-Christoph Schütz, CE-Representative

*2017

Handgeführtes batteriebetriebenes Elektrowerkzeug Typ MAP219CFM

(D) UKCA-* - Konformitätserklärung. Wir erklären in alleiniger Verantwortlichkeit, dass dieses Produkt mit den folgenden Normen oder normativen Dokumenten übereinstimmt: BS EN 62841-1, BS EN ISO 12100, BS EN ISO 13857, BS EN ISO 13854, BS EN 28662-1, BS EN 61000-6-3, BS EN 61000-6-2, BS EN ISO 14118 gemäß den Bestimmungen der Richtlinien 2006/42/EG, 2014/30/EU, 2011/65/EU
RED: BS EN IEC 62368-1, ETSI EN 301489-1, ETSI EN 301489-17, ETSI EN 300328 V2.2.2, BS EN 62479 gemäß den Bestimmungen der Richtlinien 2014/53/EU, 2011/65/EU

(GB) UKCA-* - Declaration of conformity. We declare under our sole responsibility that this product is in conformity with the following standards or normative documents: BS EN 62841-1, BS EN ISO 12100, BS EN ISO 13857, BS EN ISO 13854, BS EN 28662-1, BS EN 61000-6-3, BS EN 61000-6-2, BS EN ISO 14118 in accordance with the regulations of directives 2006/42/EG, 2014/30/EU, 2011/65/EU
RED: BS EN IEC 62368-1, ETSI EN 301489-1, ETSI EN 301489-17, ETSI EN 300328 V2.2.2, BS EN 62479 in accordance with the regulations of directives 2014/53/EU, 2011/65/EU

(F) UKCA-* - Déclaration de conformité. Nous déclarons sous notre seule responsabilité que ce produit est en conformité avec les normes ou documents normatifs suivants: BS EN 62841-1, BS EN ISO 12100, BS EN ISO 13857, BS EN ISO 13854, BS EN 28662-1, BS EN 61000-6-3, BS EN 61000-6-2, BS EN ISO 14118 conformément aux réglementations des directives 2006/42/EG, 2014/30/EU, 2011/65/EU
RED: BS EN IEC 62368-1, ETSI EN 301489-1, ETSI EN 301489-17, ETSI EN 300328 V2.2.2, BS EN 62479 conformément aux réglementations des directives 2014/53/EU, 2011/65/EU

(E) UKCA-* - Declaración de conformidad. Declaramos bajo nuestra sola responsabilidad que este producto está en conformidad con las normas o documentos normativos siguientes: BS EN 62841-1, BS EN ISO 12100, BS EN ISO 13857, BS EN ISO 13854, BS EN 28662-1, BS EN 61000-6-3, BS EN 61000-6-2, BS EN ISO 14118 de acuerdo con las regulaciones de las directivas 2006/42/EG, 2014/30/EU, 2011/65/EU
RED: BS EN IEC 62368-1, ETSI EN 301489-1, ETSI EN 301489-17, ETSI EN 300328 V2.2.2, BS EN 62479 de acuerdo con las regulaciones de las directivas 2014/53/EU, 2011/65/EU

(I) UKCA-* - Dichiarazione di conformità. Dichiariamo sotto la nostra esclusiva responsabilità che questo prodotto è conforme alle seguenti norme e documenti normativi: BS EN 62841-1, BS EN ISO 12100, BS EN ISO 13857, BS EN ISO 13854, BS EN 28662-1, BS EN 61000-6-3, BS EN 61000-6-2, BS EN ISO 14118 conformemente alle disposizioni delle direttive 2006/42/EG, 2014/30/EU, 2011/65/EU
RED: BS EN IEC 62368-1, ETSI EN 301489-1, ETSI EN 301489-17, ETSI EN 300328 V2.2.2, BS EN 62479 conformemente alle disposizioni delle direttive 2014/53/EU, 2011/65/EU

(P) UKCA-* - Declaração de conformidade. Declaramos sob nossa exclusiva responsabilidade que este produto cumpre as seguintes normas ou documentos normativos: BS EN 62841-1, BS EN ISO 12100, BS EN ISO 13857, BS EN ISO 13854, BS EN 28662-1, BS EN 61000-6-3, BS EN 61000-6-2, BS EN ISO 14118 conforme as disposições das directivas 2006/42/EG, 2014/30/EU, 2011/65/EU
RED: BS EN IEC 62368-1, ETSI EN 301489-1, ETSI EN 301489-17, ETSI EN 300328 V2.2.2, BS EN 62479 conforme as disposições das directivas 2014/53/EU, 2011/65/EU

(NL) UKCA-* - Konformiteitsverklaring. Wij verklaren en wij stellen ons er alleen voor verantwoordelijk dat dit product voldoet aan de volgende normen of normatieve documenten: BS EN 62841-1, BS EN ISO 12100, BS EN ISO 13857, BS EN ISO 13854, BS EN 28662-1, BS EN 61000-6-3, BS EN 61000-6-2, BS EN ISO 14118 overeenkomstig de bepalingen van de richtlijnen 2006/42/EG, 2014/30/EU, 2011/65/EU
RED: BS EN IEC 62368-1, ETSI EN 301489-1, ETSI EN 301489-17, ETSI EN 300328 V2.2.2, BS EN 62479 overeenkomstig de bepalingen van de richtlijnen 2014/53/EU, 2011/65/EU

(GR) UKCA-* - ΔΗΛΩΣΗ ΣΥΜΜΟΡΦΩΣΗΣ ΜΕ ε αναλυτή συνοπτικής δήλωσμοε: ότι το πορον προιον συμφωνει με τα παρωκωτα ποστοτα και με τα προτυπα ητοι αναφωρονται στα σχετικα εγγραφα BS EN 62841-1, BS EN ISO 12100, BS EN ISO 13857, BS EN ISO 13854, BS EN 28662-1, BS EN 61000-6-3, BS EN 61000-6-2, BS EN ISO 14118 συμφωνει με τοιχο κορονοτομοε 2006/42/EG, 2014/30/EU, 2011/65/EU
RED: BS EN IEC 62368-1, ETSI EN 301489-1, ETSI EN 301489-17, ETSI EN 300328 V2.2.2, BS EN 62479 συμφωνει με τοιχο κορονοτομοε 2014/53/EU, 2011/65/EU

(S) UKCA-* - Konformitetsdeklaration. Vi erklærer på eget ansvar at denne produkt overensstemmer med følgende normer eller normative dokumenter: BS EN 62841-1, BS EN ISO 12100, BS EN ISO 13857, BS EN ISO 13854, BS EN 28662-1, BS EN 61000-6-3, BS EN 61000-6-2, BS EN ISO 14118 enligt bestämmelserna i direktiverna 2006/42/EG, 2014/30/EU, 2011/65/EU
RED: BS EN IEC 62368-1, ETSI EN 301489-1, ETSI EN 301489-17, ETSI EN 300328 V2.2.2, BS EN 62479 enligt bestämmelserna i direktiverna 2014/53/EU, 2011/65/EU

(DK) UKCA-* - Konformitetserklæring. Vi erklærer under almindeligt ansvar at dette produkt er i overensstemmelse med følgende normer eller normative dokumenter: BS EN 62841-1, BS EN ISO 12100, BS EN ISO 13857, BS EN ISO 13854, BS EN 28662-1, BS EN 61000-6-3, BS EN 61000-6-2, BS EN ISO 14118 i henhold til bestemmelserne i direktiverne 2006/42/EG, 2014/30/EU, 2011/65/EU
RED: BS EN IEC 62368-1, ETSI EN 301489-1, ETSI EN 301489-17, ETSI EN 300328 V2.2.2, BS EN 62479 i henhold til bestemmelserne

*2021

i direktiverna 2014/53/EU, 2011/65/EU

(N) UKCA-* - Konformitetserklæring. Vi erklærer på eget ansvar at dette produkt er i overensstemmelse med følgende standarder eller standard-dokumenter: BS EN 62841-1, BS EN ISO 12100, BS EN ISO 13857, BS EN ISO 13854, BS EN 28662-1, BS EN 61000-6-3, BS EN 61000-6-2, BS EN ISO 14118 i henhold til bestemmelserne i direktivene nr 2006/42/EG, 2014/30/EU, 2011/65/EU
RED: BS EN IEC 62368-1, ETSI EN 301489-1, ETSI EN 301489-17, ETSI EN 300328 V2.2.2, BS EN 62479 i henhold til bestemmelserne i direktivene nr 2014/53/EU, 2011/65/EU

(FIN) UKCA-* - Todistus standardinmukaudesta. Asiasta vastaavana todistamme täten, että tämä tuote on seuraavien standardien ja standardomaisuuksien vaatimusten mukainen: BS EN 62841-1, BS EN ISO 12100, BS EN ISO 13857, BS EN ISO 13854, BS EN 28662-1, BS EN 61000-6-3, BS EN 61000-6-2, BS EN ISO 14118 ja vastaa säädöksiä 2006/42/EG, 2014/30/EU, 2011/65/EU
RED: BS EN IEC 62368-1, ETSI EN 301489-1, ETSI EN 301489-17, ETSI EN 300328 V2.2.2, BS EN 62479 ja vastaa säädöksiä 2014/53/EU, 2011/65/EU

(SK) UKCA-* - Prehľadzenie o zhode. Prehľadujeme na vlastnú zodpovednosť, že tieto produkty sú v súlade s nasledujúcimi normami: BS EN 62841-1, BS EN ISO 12100, BS EN ISO 13857, BS EN ISO 13854, BS EN 28662-1, BS EN 61000-6-3, BS EN 61000-6-2, BS EN ISO 14118 a v zhode so smernicami 2006/42/EG, 2014/30/EU, 2011/65/EU
RED: BS EN IEC 62368-1, ETSI EN 301489-1, ETSI EN 301489-17, ETSI EN 300328 V2.2.2, BS EN 62479 a v zhode so smernicami 2014/53/EU, 2011/65/EU

(PL) UKCA-* - Zgodność z dyrektywami UKCA. Świadom odpowiedzialności oświadczamy, że niniejszy produkt jest zgodny z następującymi normami lub dokumentacją normatywną: BS EN 62841-1, BS EN ISO 12100, BS EN ISO 13857, BS EN 28662-1, BS EN 61000-6-3, BS EN 61000-6-2, BS EN ISO 14118 zgodnie z postanowieniami wytycznych 2006/42/EG, 2014/30/EU, 2011/65/EU
RED: BS EN IEC 62368-1, ETSI EN 301489-1, ETSI EN 301489-17, ETSI EN 300328 V2.2.2, BS EN 62479 zgodnie z postanowieniami wytycznych 2014/53/EU, 2011/65/EU

(CZ) UKCA-* - Prohlášení o shodě. Prohlášíme na vlastní zodpovědnost, že tyto produkty splňují následující normy nebo normativní listiny: BS EN 62841-1, BS EN ISO 12100, BS EN ISO 13857, BS EN ISO 13854, BS EN 28662-1, BS EN 61000-6-3, BS EN 61000-6-2, BS EN ISO 14118. Ve shodě se směrnicemi 2006/42/EG, 2014/30/EU, 2011/65/EU
RED: BS EN IEC 62368-1, ETSI EN 301489-1, ETSI EN 301489-17, ETSI EN 300328 V2.2.2, BS EN 62479 ve shodě se směrnicemi 2014/53/EU, 2011/65/EU

(SLO) UKCA-* - Izjava o skladnosti. S tem potrjujemo splošno odgovornost, da je ta izdelek narejen v skladu z navedenimi normami in standardi: BS EN 62841-1, BS EN ISO 12100, BS EN ISO 13857, BS EN ISO 13854, BS EN 28662-1, BS EN 61000-6-3, BS EN 61000-6-2, BS EN ISO 14118 ter določbami in smernicami 2006/42/EG, 2014/30/EU, 2011/65/EU
RED: BS EN IEC 62368-1, ETSI EN 301489-1, ETSI EN 301489-17, ETSI EN 300328 V2.2.2, BS EN 62479 ter določbami in smernicami 2014/53/EU, 2011/65/EU

(HR) UKCA-* - Izjava o skladnosti. Pod punom odgovornošću izjavljujemo da je proizvod naveden u naslovu ovog dokumenta skladan za primijenjeni normama i normativnim dokumentima: BS EN 62841-1, BS EN ISO 12100, BS EN ISO 13857, BS EN ISO 13854, BS EN 28662-1, BS EN 61000-6-3, BS EN 61000-6-2, BS EN ISO 14118 u skladu sa odredbama preporuka 2006/42/EG, 2014/30/EU, 2011/65/EU
RED: BS EN IEC 62368-1, ETSI EN 301489-1, ETSI EN 301489-17, ETSI EN 300328 V2.2.2, BS EN 62479 u skladu sa odredbama preporuka 2014/53/EU, 2011/65/EU

(HU) UKCA-* - Megfelelőségi nyilatkozás. Kéziműkötésű elektromos kéziszerszámok: Teljes felelősségű kijelentjük, hogy ezek a termékek a következő szabványokkal és irányelvekkel összhangban vannak: BS EN 62841-1, BS EN ISO 12100, BS EN ISO 13857, BS EN ISO 13854, BS EN 28662-1, BS EN 61000-6-3, BS EN 61000-6-2, BS EN ISO 14118; és megfelelnek a rendeltetés szerinti 2006/42/EG, 2014/30/EU, 2011/65/EU irányelveknek.
RED: BS EN IEC 62368-1, ETSI EN 301489-1, ETSI EN 301489-17, ETSI EN 300328 V2.2.2, BS EN 62479 és megfelelnek a rendeltetés 2014/53/EU, 2011/65/EU irányelveknek.

(RO) UKCA-* - Declarație de conformitate. Noi declarăm pe propria răspundere că acest produs este în conformitate cu următoarele norme și documente normative: BS EN 62841-1, BS EN ISO 12100, BS EN ISO 13857, BS EN ISO 13854, BS EN 28662-1, BS EN 61000-6-3, BS EN 61000-6-2, BS EN ISO 14118; potrivit dispozițiilor directivelor 2006/42/EG, 2014/30/EU, 2011/65/EU
RED: BS EN IEC 62368-1, ETSI EN 301489-1, ETSI EN 301489-17, ETSI EN 300328 V2.2.2, BS EN 62479 potrivit dispozițiilor directivelor 2014/53/EU, 2011/65/EU

(RU) UKCA-* - Декларация о соответствии. Мы подтверждаем ответственностью, что данный продукт соответствует следующим нормам и нормативным документам: BS EN 62841-1, BS EN ISO 12100, BS EN ISO 13857, BS EN ISO 13854, BS EN 28662-1, BS EN 61000-6-3, BS EN 61000-6-2, BS EN ISO 14118; и соответствуют требованиям 2006/42/EG, 2014/30/EU, 2011/65/EU.
RED: BS EN IEC 62368-1, ETSI EN 301489-1, ETSI EN 301489-17, ETSI EN 300328 V2.2.2, BS EN 62479 и соответствуют требованиям 2014/53/EU, 2011/65/EU.

(UK) UKCA-* - Declaration of conformity. We declare under our sole responsibility that this product is in conformity with the following standards or normative documents: BS EN 62841-1, BS EN ISO 12100, BS EN ISO 13857, BS EN ISO 13854, BS EN 28662-1, BS EN 61000-6-3, BS EN 61000-6-2, BS EN ISO 14118 in accordance with the regulations of directives 2006/42/EG, 2014/30/EU, 2011/65/EU
RED: BS EN IEC 62368-1, ETSI EN 301489-1, ETSI EN 301489-17, ETSI EN 300328 V2.2.2, BS EN 62479 in accordance with the regulations of directives 2014/53/EU, 2011/65/EU

(US) UKCA-* - Declaration of conformity. We declare under our sole responsibility that this product is in conformity with the following standards or normative documents: BS EN 62841-1, BS EN ISO 12100, BS EN ISO 13857, BS EN ISO 13854, BS EN 28662-1, BS EN 61000-6-3, BS EN 61000-6-2, BS EN ISO 14118 in accordance with the regulations of directives 2006/42/EG, 2014/30/EU, 2011/65/EU
RED: BS EN IEC 62368-1, ETSI EN 301489-1, ETSI EN 301489-17, ETSI EN 300328 V2.2.2, BS EN 62479 in accordance with the regulations of directives 2014/53/EU, 2011/65/EU



Joh. - Christoph Schütz
Dipl.-Ing. Joh. Christoph Schütz, CE-Representative