



www.klauke.com

EKM 60IDCFM



Serialnumber



UL/CSA
62841-1



CLASSIFIED
UL US
E244184

UK
CA Klauke UK Ltd.
NR35 1JX



IEC
62841-1



HE.16832_J © 05/2016 R&D-2

Gustav Klauke GmbH • Auf dem Knapp 46 • D-42855 Remscheid • Telefon +49 2191 907 0 • www.klauke.com

Klauke®

**2 Jahre
Garantie**

Wir freuen uns, dass Sie sich für ein Klauke Werkzeug entschieden haben und wünschen Ihnen viel Freude damit.

**Weltweiter
Werkzeug
Service**
Klauke ASC
Authorized Service Center

Sie haben ein Qualitätsprodukt „Made in Germany“ erworben und erhalten 2 Jahre Garantie. Diese beginnt mit dem Kaufbelegdatum.

Um lange Freude und eine einwandfreie Funktion des Werkzeuges sicherzustellen, muss das Gerät spätestens beim Erreichen von 10.000 Arbeitsvorgängen oder nach 3 Jahren durch ein Autorisiertes Service Center (ASC) gewartet werden. Wird das Wartungsintervall von 10.000 Arbeitsvorgängen nicht eingehalten, erlischt der Garantieanspruch.

Im Rahmen dieser Wartung werden verschlissene Teile ersetzt und sicherheitsrelevante Teile geprüft und ggf. vorbeugend ersetzt.

Darüber hinaus empfehlen wir das Gerät jährlich zur Überprüfung an das zuständige ASC einzusenden.

Für Fragen rund um unseren Werkzeugservice stehen wir Ihnen unter folgenden Rufnummern persönlich zur Verfügung:

Technik +492332709544

Reparaturen / Leihgeräte +492332709540



Ihr Klauke-Service Team



Die Bluetooth®-Wortmarke und das Bluetooth®-Symbol sind eingetragene Warenzeichen der Bluetooth SIG, Inc. und jegliche Verwendung durch Gustav Klauke GmbH ist lizenziert.

**2 years
Warranty**

Thank you for choosing a Klauke tool. We hope it gives you lots of pleasure.

**World wide
Tool
Service**
Klauke ASC
Authorized Service Center

You have purchased a quality product „Made in Germany“, which is covered by a 2 year warranty. The warranty commences from the purchase receipt date.

To ensure lasting enjoyment and a flawless tool function, the product must be serviced by an Authorised Service Center (ASC) after 10,000 operations or after 3 years. Should the service Interval exceed 10.000 cycles the warranty claim is void.

The Service includes predictive maintenance in which worn-out parts will be replaced and safety relevant parts checked/replaced.

We recommend to have the tools checked yearly through an Authorized Service Center (ASC).

For questions about our tool service we are personally available under the following telephone numbers:

Technical Support +492332709544

Repairs / Loaner tools +492332709540



Your Klauke-Service Team



The Bluetooth® word mark and Bluetooth® symbol are registered trademarks of Bluetooth SIG, Inc. and any use by Gustav Klauke GmbH is licensed.



EKM 60IDCFM

Klauke

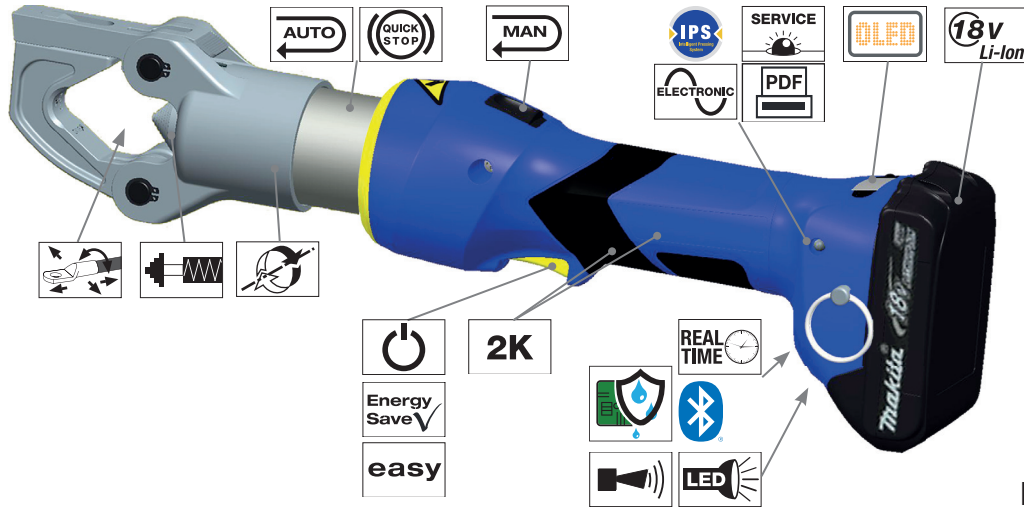

optional:
 BL1850(B) (RAL4)
 BL1840(B) (RAL40)
 BL1830(B) (RAL2)



datecode

Year	Code	Month	Code	Month	Code
2022	R	Jan.	N	July	V
2023	S	Feb.	P	Aug.	W
2024	T	Mar.	Q	Sept.	X
2025	V	Apr.	R	Oct.	Y
2026	W	May	S	Nov.	Z
2027	X	June	T	Dec.	1

For US and Canada only

FCC ID: RFR-850 • IC: 4957A-850
 Model: CFI
 This device complies with Part 15 of the FCC Rules and with Industry Canada license-exempt RSS standard(s). Operation is subject to the following two conditions: (1) this device may not cause harmful interference, and (2) this device must accept any interference received, including interference that may cause undesired operation.

batch# e.g. 304711
 datecode e.g. X = 2027; R = April
 consecutive# e.g. „142“ = tool # 142

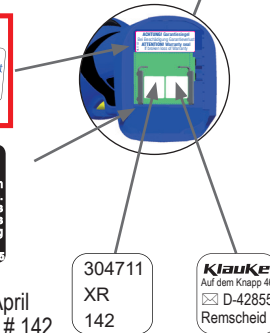



EKM 60IDCFM

Klauke

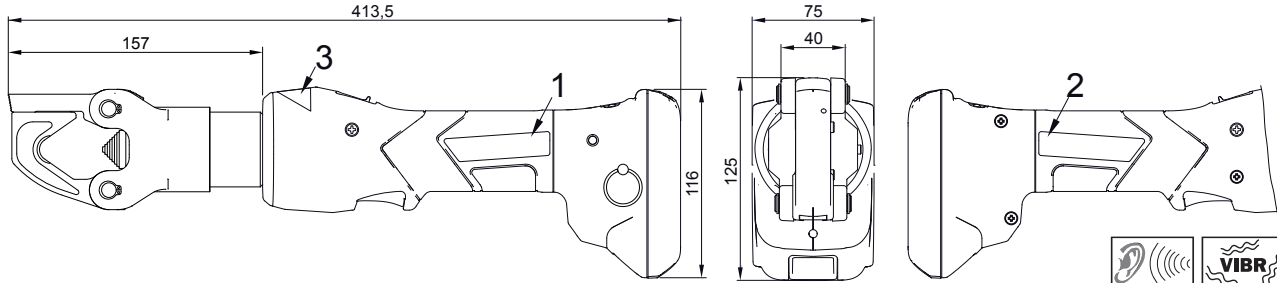

 <70dB	 VIBR <2,5m/s²
 +40°C -10°C	 Bio
 2,5 kg	 6 ton
IP 44	

WARNING

Read all safety warnings, instructions, illustrations and specifications provided with this power tool.

Failure to follow all instructions listed below may result in electric shock, fire and/or serious injury.

Save all warnings and instructions for future reference.





EKM 60IDCFM

Use tool only with 18 V Makita battery



Makita BL1840 IEC61950
18V ~ 4.0Ah 72Wh

Makita Corporation 603992-6

Makita BL1850 IEC61950
18V ~ 5.0Ah 90Wh

Makita Corporation 603992-6

Makita Li-ion
BL1830 18V ~ 3.0Ah 54Wh

Makita Corporation 610964-1
Made in Japan

Makita Li-ion
BL1815 18V ~ 24Wh

Makita Corporation 616334-1
Made in Japan

- BL1850(B) 45 min.
RAL4
- BL1840(B) 36 min.
RAL40
- BL1830(B) 22 min.
RAL2
- BL1815 15 min.
RAL1
- 10 - 40°C



Makita
DC18RC

Li-ion & Ni-MH 7.2-18V

Makita DC18RC T
Prim.: 220V ~ 240V ~ 240W 50 ~ 60Hz
Sek.: 7.2V ~ 18V ~ 9A
0505611

CH.P/N: 630718-5
Makita Corporation 669950-6

Alle Bedienungsanleitungen auch unter www.klauke.de abrufbar
All manuals are also available on www.klauke.com





EKM 60IDCFM

Klauke

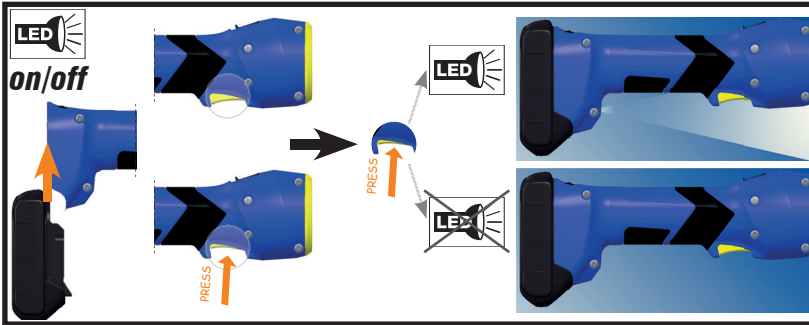
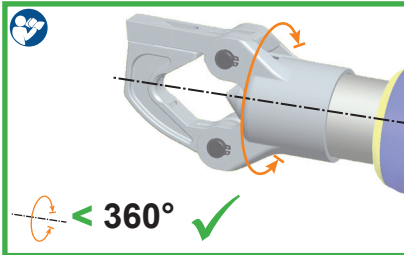

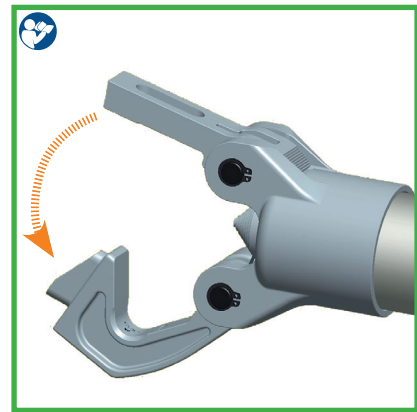
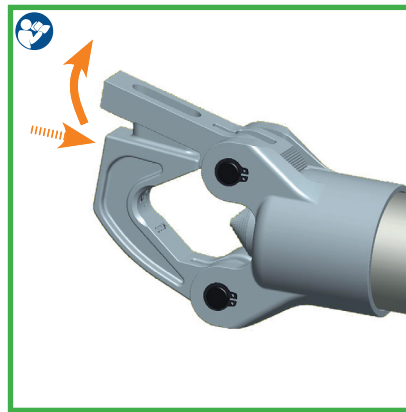
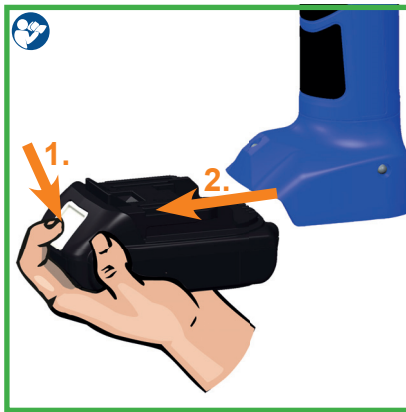
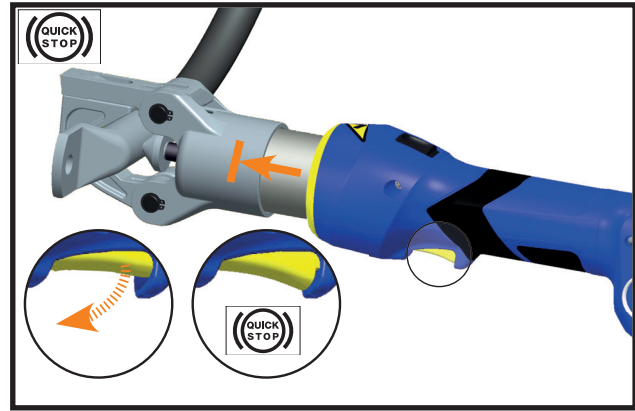
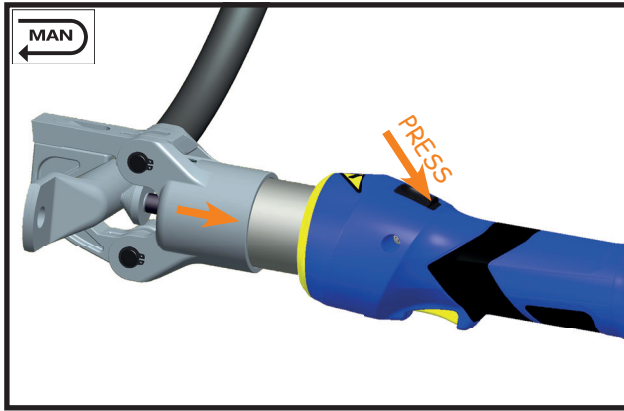

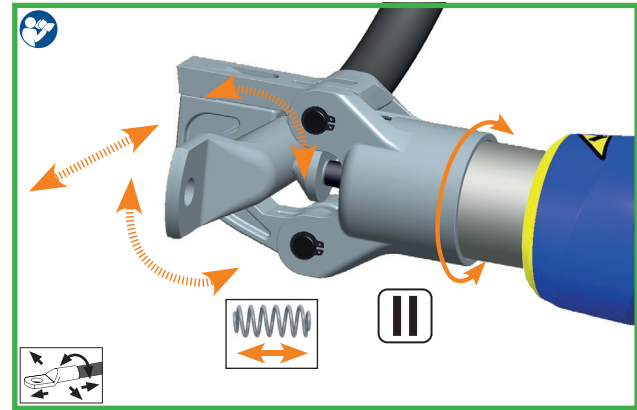
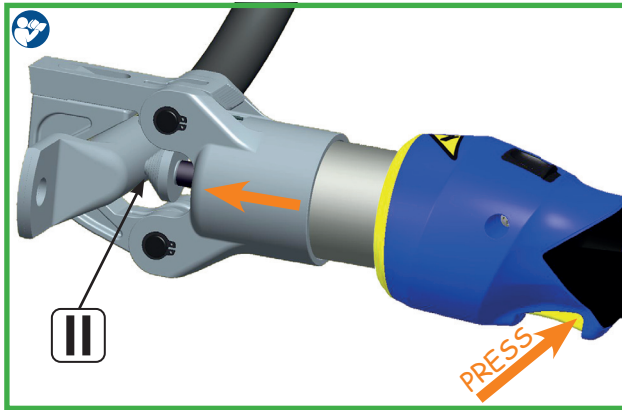
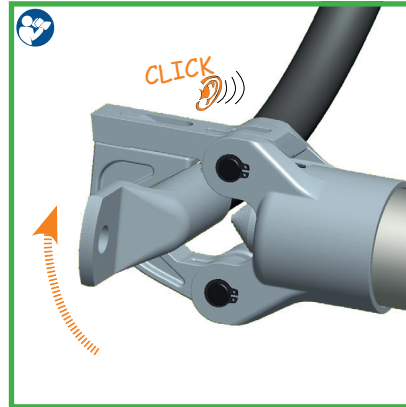

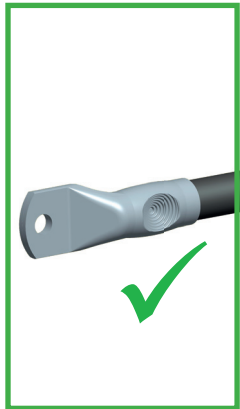
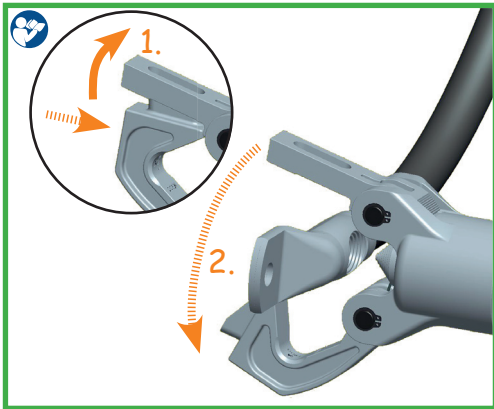
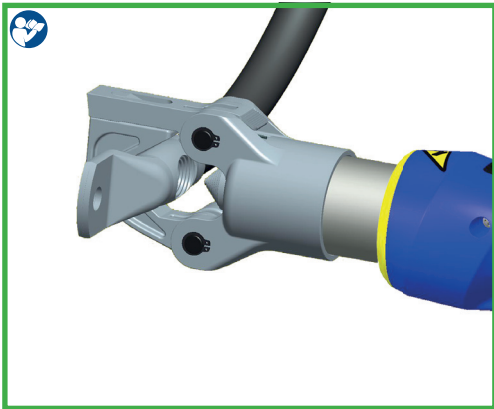
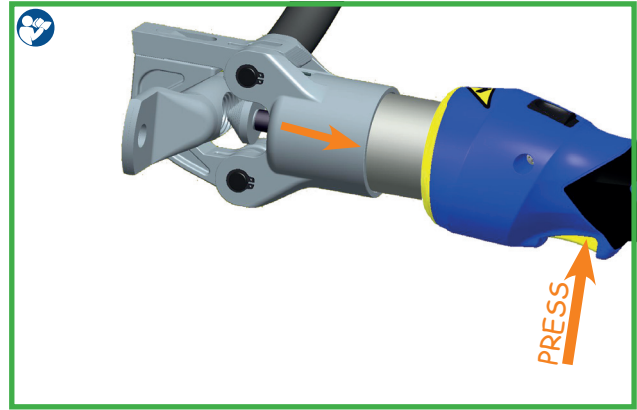
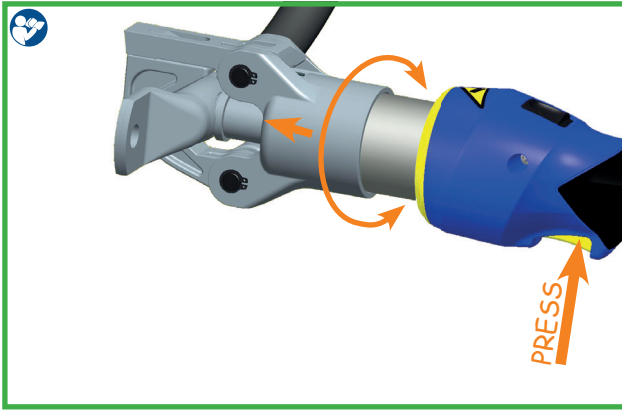



1		
2		
	ERROR CODE: ****	Error code *1
3		Bluetooth (if connected) Battery charging level Current pressure Pressure max. *2
4a		USER 3: RD3 Doppelklick Doubleclick
4b		USER SELECT 3: RD3 Einfachklick Singleclick enter menu
4c		USER SELECT: RD3 Doppelklick Doubleclick select
4d		USER SELECT: RD3 Doppelklick Doubleclick confirmed additional profiles: MRS+ Single Click MRS+ Double Click
5		Cycles (until next service)
6		Since manufacturing: operating hours Capacity # crimps
7		

- *1 Error codes/ Fehlermeldungen:
- 1 Overcurrent fuse
 - 2 Overcurrent comparator
 - 3 Overheat board
 - 4 Overheat battery
 - 5 Battery empty, operation stop
 - 6 Faulty crimp motor in operation
 - 7 Faulty crimp motor not in operation
 - 8 Low battery
 - 9 Battery empty
 - 10 RTC battery low
 - 12 Service necessary
 - 13 RTC not found
 - 14 BT unit not found
 - 15 Mobile unit not found
 - 16 Pressure sensor not found
 - 17 Burst pressure exceeded
 - 18 Battery temperature too low
 - 19 Battery reserves
 - 20 Overcurrent fuse (I)
 - 21 Remote Control Battery Low*
 - 22 Service necessary SAST1
 - 23 Service necessary SAST2
 - 24 Service necessary SAST3
 - 25 Remote mode: tool trigger not actuated*
 - 27 Overheat motor
 - 28 Service necessary: Pressure low
 - 29 Service necessary: Pressure high
- 1 Überstromsicherung
2 Überstromsicherung durch Komparator
3 Boardtemperatur zu hoch
4 Akkutemperatur zu hoch
5 Akkuspannung zu gering
6 Fehlpressung bei laufendem Motor
7 Fehlpressung bei stehendem Motor
8 Niedrige Akkuspannung
9 Akku leer
10 RTC-Batterie leer
12 Service nötig
13 RTC nicht verfügbar
14 BT-Modul nicht verfügbar
15 Modul nicht verfügbar
16 Drucksensor nicht verfügbar
17 Berstdruck überschritten
18 Akkutemperatur zu gering
19 Batteriereserven zu gering
20 Überstromsicherung (I)
21 Fernbedienung-Batterie schwach*
22 Service notwendig SAST1
23 Service notwendig SAST2
24 Service notwendig SAST3
25 Remote-Modus: WZ-Taster nicht betätigt*
27 Motortemperatur zu hoch
28 Service notwendig: Druck niedrig
29 Service notwendig: Druck hoch
* remote control tools only/
nur bei fernbedienbaren Werkzeugen

*2 (2Hz)





Klauke i-press® Software

▶ www.klauke.com/connectivity



Klauke i-press® App

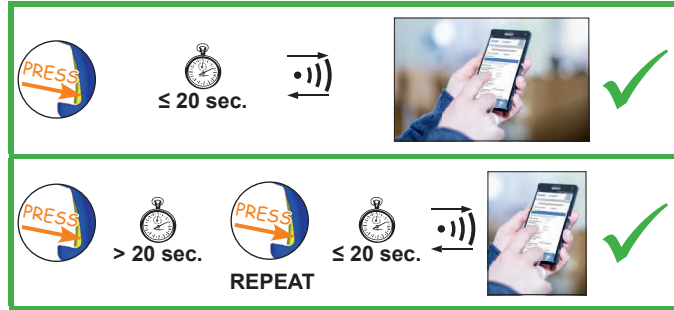

Le présent appareil est conforme aux CNR d'Industrie Canada applicables aux appareils radio exempts de licence. L'exploitation est autorisée aux deux conditions suivantes:

- (1) l'appareil ne doit pas produire de brouillage, et
- (2) l'utilisateur de l'appareil doit accepter tout brouillage radioélectrique subi, même si le brouillage est susceptible d'en compromettre le fonctionnement.

NOTICE:

Changes or modifications made to this equipment not expressly approved by Klauke may void the FCC authorization to operate this equipment.





Manual Retraction Stop +

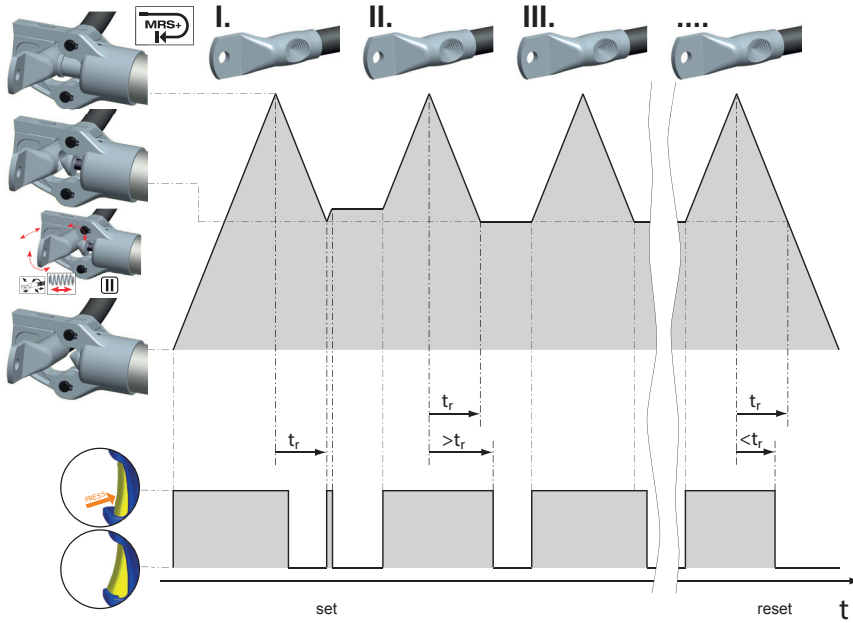



EKM 60IDCFM

Klauke

BEFORE WORK

DIN EN 50110

2 years Warranty
World wide Tool Service
Klauke ASC
Professional Service Center

1. 2. 3.

Klauke

once a year

Klauke ASC
Authorised Service Center

Recommendation
Empfehlung

3 years or 10.000 operations

OLD PART REPLACEMENT SAFETY NEW

2 years Warranty
World wide Tool Service
Klauke ASC
Professional Service Center









Klauke ASC
Authorised Service Center

WEEE 2012/19/EU

Klauke-WEEE-Abholung@Emerson.com





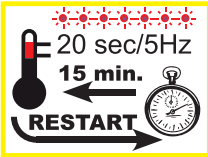



Klauke ASC
Authorised Service Center



			<p>Wann/When/Quand/Quando/ cuándo/Wanneer/Когда/это происходит/Kiedy/quando</p>	<p>Warum/Why/Pourquoi/Porquê/ ¿por qué?/Waarom/Причина/ Dlaczego/Perché</p>
 20 sec			<p>nach Arbeitsvorgang after working cycle après opération de travail Después del proceso de trabajo após o processo de trabalho na bedrijfscyclus после цикла опрессовки po zakończeniu pracy dopo il processo di lavoro</p>	
 20 sec/2Hz			<p>nach Arbeitsvorgang after working cycle après opération de travail Después del proceso de trabajo após o processo de trabalho na bedrijfscyclus после цикла опрессовки po zakończeniu pracy dopo il processo di lavoro</p>	 
 20 sec/5Hz			<p>während der Übertemperatur while exceeding the temp. limit pendant surchauffe en caso de temperatura excesiva durante a temperatura excessiva tijdens te hoge temperatuur при высокой температуре внутри корпуса przy przegrzaniu superando il limite di temperatura</p>	<p>Werkzeug zu heiß Unit too hot outil surchauffé Herramienta demasiado caliente ferramenta demasiado quente gereedschap te heet Перегрев инструмента urządzenie za gorące Utensile troppo caldo</p> 















SERVICE 	LED 		Wann/When/Quand/Quando/ cuándo/Wanneer/Когда/это происходит/Kiedy/quando	Warum/Why/Pourquoi/Porquê/ ¿por qué?/Waarom/Причина/ Dlaczego/Perché
 1 x	 1 x		nach Arbeitsvorgang after working cycle après opération de travail Después del proceso de trabajo após o processo de trabalho na bedrijfsscyclus после цикла опрессовки po zakończeniu pracy dopo il processo di lavoro	Fehler: der notwendige Pressdruck wurde nicht erreicht. Es handelt sich um eine manuelle Unterbrechung der Pressung bei stehendem Motor. Error: the required pressure has not been reached. The operator has interrupted the pressing cycle manually while the motor was not running. ERREUR: Pression necessaire pas atteinte. Il s'agit d'une interruption manuelle de la sertissage au moteur arrêté. Error: No se ha alcanzado la presión necesaria o el operador ha interrumpido el ciclo a mano mientras el motor ha parado. Falha: a pressão de prensagem necessária não foi alcançada. Trata-se de uma interrupção manual da prensagem com o motor parado. Foutmelding: De benodigde persdruk wordt niet bereikt. De gebruiker heeft de verkrimping handmatig stopgezet aangezien de motor niet actief is. Ошибка: не было достигнуто требуемое усилие опрессовки или оператор прервал процесс опрессовки вручную, когда двигатель остановился. Błąd: konieczne ciśnienie nie zostało osiągnięte. Użytkownik przerwał cykl pracy ręcznie w chwili, gdy silnik nie był włączony Errore: la pressione richiesta non è stata raggiunta. L'operatore ha interrotto manualmente il ciclo di pressatura mentre il motore non è in funzione.
 3 x	 3 x		nach Arbeitsvorgang after working cycle après opération de travail Después del proceso de trabajo após o processo de trabalho na bedrijfsscyclus после цикла опрессовки po zakończeniu pracy dopo il processo di lavoro	Schwerwiegender Fehler: Pressdruck wurde bei laufendem Motor nicht erreicht. Serious Error: The pressure has not been reached while the motor was running. Erreur Grave: Pression pas atteinte au moteur courant. Error grave: No se ha alcanzado presión mientras el motor estaba en marcha Falha grave: a pressão de prensagem não foi alcançada com o motor em funcionamento. Urgente foutmelding: De persdruk werd bij een werkende motor niet bereikt. Серьезная ошибка: не было достигнуто требуемое усилие опрессовки во время работы двигателя Poważny błąd: konieczne ciśnienie nie zostało osiągnięte podczas pracy silnika Errore grave: la pressione non è stata raggiunta mentre il motore è in funzione.



Tab. 2

	Verb. material Connection material	Pressbereich mm ² Crimping range mm ²	Press- form Crimping mold	Kenn- zeichnung Marking
Rohrkabelschuhe und Verbinder - Cu Copper tubular cable lugs and connectors - Cu				
Rohrkabelschuhe und Verbinder „Normalausführung“, Rohrkabelschuhe für Schaltgeräteanschlüsse Tubular cable lugs and connectors, „standard type“, tubular; cable lugs for switchgear connections		16 - 240		K60ID
Rohrkabelschuhe und Verbinder für feindrähtige Leiter Tubular cable lugs and connectors for fine stranded conductors		10 - 240		
Quetschkabelschuhe, Verbinder und Stiftkabelschuhe nach DIN - Cu Solderless terminals, connectors and pin terminals to DIN - Cu				
Quetschkabelschuhe (DIN 46234), Verbinder (DIN 46341) und Stiftkabelschuhe (DIN 46230) - Cu Solderless terminals (DIN 46234), connectors (DIN 46341) pin terminals (DIN 46230) - Cu		10 - 240		K60ID
Presskabelschuhe und Verbinder nach DIN - Al Compression cable lugs and connectors to DIN - Al				
Presskabelschuhe und Verbinder nach DIN - Al Aluminium compression cable lugs and connectors to DIN - Al		50 - 240		K60ID
Pressverbinder für zugfeste Verbindungen von Aldrey-Seilen nach DIN EN 50182, Al-Leiter DIN EN 50182, 120-185 mm ² Compression joints for full-tension connections of Aldrey conductors acc. to DIN EN 50182, Al-conductors DIN EN 50182, 120-185 mm ²		50 - 185		



	Verb. material Connection material	Pressbereich mm ² Crimping range mm ²	Press- form Crimping mold	Kenn- zeichnung Marking
Presskabelschuhe und Verbinder nach DIN - Al Compression cable lugs and connectors to DIN - Al				
Pressverbinder nach DIN 48085, Teil 2 für Al-Seile DIN EN 50182 Compression joints to DIN 48085, part 2 for Al-cables DIN EN 50182	Al 	50 - 185		K60ID
Presskabelschuhe und Verbinder - Al/Cu Compression cable lugs and connectors - Al/Cu				
Presskabelschuhe und Verbinder - Al/Cu Compression cable lugs and connectors - Al/Cu	Al/Cu 	50-240		K60ID



Klauke® Crimp Chart EKM60IDxxx tool series*1

Quad point indenter crimps

Klauke Q-series (Class 5 & 6) Copper connector type	Ring type	Fork type	Pin type	Splices
Copper lugs Q-series	1652xx -1662xx	1652Cxx-1653Cxx	ST1716 - ST1722	
Klauke F-series (Class 5 & 6) Copper connector type	Ring type	Angle type 90°		Splices
Copper lugs F-series	702Fxx - 712Fxx*2	742Fxx - 752Fxx*2		
Copper slices F-series				722F - 731F*2
Klauke R-series (Class 2 & 5) Copper connector type	Ring type	Angle type 90°	Angle type 45°	Splices
Copper lugs R-series	3Rxx-12Rxx*2	43Rxx- 52Rxx*2	43Rxx45-52Rxx45*2	
Copper slices R-series				23R-32R*2
T-splices R-series				TV16-TV240*2
Cross-Splices				KV16-KV240*2
Lugs for switch gear conn.	5SGxx-12SGxx*2			
Klauke L-series (Class 2, 5 & 6) Copper connector type	Ring type	Angle type 90°	Angle type 45°	Splices
Copper lugs L-series	L16xxxx-L240xxxx*2	L16xx90-L240xx90*2	L16xx45-L240xx45*2	
Copper slices L-series				LV16-LV240*2
Number of crimps	1*1	1*1	1*1	
Klauke AL-series Alu connector type	Ring type	Angle type 90°	Angle type 45°	Splices
Aluminium lugs AL-series (Class 2)	267Rxx-272Rxx			
Number of crimps	2*1			

HE15801_F

*1 EKM60ID, HK60ID, PK60ID

*2 1 crimp required, 2 crimps recommended @ 240mm² (see chart in main catalog)



Handgeführtes batteriebetriebenes Elektrowerkzeug Typ EKM60IDCFM

Klauke

(D) CE-* - Konformitätserklärung. Wir erklären in alleiniger Verantwortlichkeit, daß dieses Produkt mit den folgenden Normen oder normativen Dokumenten übereinstimmt: EN 62841-1, EN ISO 12100, EN ISO 13857, EN ISO 13854, EN 28662-1, EN 61000-6-3, EN 61000-6-2, EN 60529, EN ISO 14118 gemäß den Bestimmungen der Richtlinien 2006/42/EG, 2014/30/EU, 2011/65/EU

(GB) CE-* - Declaration of conformity. We declare under our sole responsibility that this product is in conformity with the following standards or normative documents: EN 62841-1, EN ISO 12100, EN ISO 13857, EN ISO 13854, EN 28662-1, EN 61000-6-3, EN 61000-6-2, EN 60529, EN ISO 14118 in accordance with the regulations of directives 2006/42/EG, 2014/30/EU, 2011/65/EU

(F) CE-* - Déclaration de conformité. Nous déclarons sous notre seule responsabilité que ce produit est en conformité avec les normes ou documents normatifs suivants: EN 62841-1, EN ISO 12100, EN ISO 13857, EN ISO 13854, EN 28662-1, EN 61000-6-3, EN 61000-6-2, EN 60529, EN ISO 14118 conformément aux réglementations des directives 2006/42/EG, 2014/30/EU, 2011/65/EU

(E) CE-* - Declaración de conformidad. Declaramos bajo nuestra sola responsabilidad que este producto está en conformidad con las normas o documentos normativos siguientes: EN 62841-1, EN ISO 12100, EN ISO 13857, EN ISO 13854, EN 28662-1, EN 61000-6-3, EN 61000-6-2, EN 60529, EN ISO 14118 de acuerdo con las regulaciones de las directivas 2006/42/EG, 2014/30/EU, 2011/65/EU

(I) CE-* - Dichiarazione di conformità. Dichiariamo sotto la nostra esclusiva responsabilità che questo prodotto è conforme alle seguenti norme e documenti normativi: EN 62841-1, EN ISO 12100, EN ISO 13857, EN ISO 13854, EN 28662-1, EN 61000-6-3, EN 61000-6-2, EN 60529, EN ISO 14118 conformemente alle disposizioni delle direttive 2006/42/EG, 2014/30/EU, 2011/65/EU

(P) CE-* - Declaração de conformidade. Declaramos sob nossa exclusiva responsabilidade que este produto cumpre as seguintes normas ou documentos normativos: EN 62841-1, EN ISO 12100, EN ISO 13857, EN ISO 13854, EN 28662-1, EN 61000-6-3, EN 61000-6-2, EN 60529, EN ISO 14118 conforme as disposições das directivas 2006/42/EG, 2014/30/EU, 2011/65/EU

(NL) CE-* - Konformiteitsverklaring. Wij verklaren en wij stellen ons er alleen voor verantwoordelijk dat dit product voldoet aan de volgende normen of normatieve documenten: EN 62841-1, EN ISO 12100, EN ISO 13857, EN ISO 13854, EN 28662-1, EN 61000-6-3, EN 61000-6-2, EN 60529, EN ISO 14118 overeenkomstig de bepalingen van de richtlijnen 2006/42/EG, 2014/30/EU, 2011/65/EU

(GR) CE-* - ΔΗΛΩΣΗ ΣΥΜΜΟΡΦΩΣΗΣ Με αναληψη συνολικης δηλωνομε οτι το πορον προιον συμφωρει με τα παρακατω ποστυπα και με τα προτυπα ηου αναφερονται στα σχετικο εγγραφα EN 62841-1, EN ISO 12100, EN ISO 13857, EN ISO 13854, EN 28662-1, EN 61000-6-3, EN 61000-6-2, EN 60529, EN ISO 14118 συμφωνα με τοχς κοινοισμους 2006/42/EG, 2014/30/EU, 2011/65/EU

(S) CE-* - Konformitetsdeklaration. Vi förklarar på eget ansvar att denna produkt överensstämmer med följande normer eller normativa dokument: EN 62841-1, EN ISO 12100, EN ISO 13857, EN ISO 13854, EN 28662-1, EN 61000-6-3, EN 61000-6-2, EN 60529, EN ISO 14118 enligt bestämmelserna i direktiverna 2006/42/EG, 2014/30/EU, 2011/65/EU

(DK) CE-* - Konformitetserklæring. Vi erklærer under almindeligt ansvar at dette produkt er i overensstemmelse med følgende normer eller normative dokumenter: EN 62841-1, EN ISO 12100, EN ISO 13857, EN ISO 13854, EN 28662-1, EN 61000-6-3, EN 61000-6-2, EN 60529, EN ISO 14118 i henhold til bestemmelserne i direktiverne 2006/42/EØF, 2014/30/EU, 2011/65/EU

(N) CE-* - Konformitetserklæring. Vi erklærer på eget ansvar at dette produkt er i overensstemmelse med følgende standarder eller standard-dokumenter: EN 62841-1, EN ISO 12100, EN ISO 13857, EN ISO 13854, EN 28662-1, EN 61000-6-3, EN 61000-6-2, EN 60529, EN ISO 14118 i henhold til bestemmelserne i direktivene 2006/42/EØF, 2014/30/EU, 2011/65/EU

(FIN) CE-* - Todistus standardinmukaisuudesta. Asiaa vastaavana todistamme täten, että tämä tuote on seuraavien standardien ja standardoimisasiakirjojen vaatimusten mukainen: EN 62841-1, EN ISO 12100, EN ISO 13857, EN ISO 13854, EN 28662-1, EN 61000-6-3, EN 61000-6-2, EN 60529, EN ISO 14118 ja vastaa säädöksiä 2006/42/EG, 2014/30/EU, 2011/65/EU

(SK) CE-* - Prehlásenie o zhode. Prehlasujeme na vlastnú zodpovednosť, že tieto produkty sú v súlade s nasledovnými normami: EN 62841-1, EN ISO 12100, EN ISO 13857, EN ISO 13854, EN 28662-1, EN 61000-6-3, EN 61000-6-2, EN 60529, EN ISO 14118 a v zhode so smerniciami 2006/42/EG, 2014/30/EU, 2011/65/EU

(PL) CE-* - Zgodność z dyrektywami CE. Świadomi odpowiedzialności oświadczamy, że niniejszy produkt jest zgodny z następującymi normami lub dokumentacją normatywną: EN 62841-1, EN ISO 12100, EN ISO 13857, EN ISO 13854, EN 28662-1, EN 61000-6-3, EN 61000-6-2, EN 60529, EN ISO 14118 zgodnie z postanowieniami wytycznych 2006/42/EG, 2014/30/EU, 2011/65/EU

(CZ) CE-* - Prohlášení o shodě. Prohlasujeme na vlastní zodpovědnost, že tyto produkty splňují následující normy nebo normativní listiny: EN 62841-1, EN ISO 12100, EN ISO 13857, EN ISO 13854, EN 28662-1, EN 61000-6-3, EN 61000-6-2, EN 60529, EN ISO 14118; Ve shodě se směrnicemi 2006/42/EG, 2014/30/EU, 2011/65/EU

(SLO) CE-* - Izjava o skladnosti. S tem potrjujemo splošno odgovornost, da je ta izdelek narejen v skladu z navedenimi normami in standardi: EN 62841-1, EN ISO 12100, EN ISO 13857, EN ISO 13854, EN 28662-1, EN 61000-6-3, EN 61000-6-2, EN 60529, EN ISO 14118 ter določbami in smernicami 2006/42/EG, 2014/30/EU, 2011/65/EU

(HR) CE-* - Izjava o sukladnosti. Pod punom odgovornošću izjavljujemo da je proizvod naveden u naslovu ovog dokumenta sukladan sa primijenjenim normama i normativnim dokumentima : EN 62841-1, EN ISO 12100, EN ISO 13857, EN ISO 13854, EN 28662-1, EN 61000-6-3, EN 61000-6-2, EN 60529, EN ISO 14118 u skladu sa odredbama preporuka 2006/42/EG, 2014/30/EU, 2011/65/EU

(H) CE-* - Megfelelősségi nyilatkozat. Kéziműködtetésű elektromos kéziszerszámok: Teljes felelősséggel kijelentjük, hogy ezek a termékek a következő szabványokkal és irányelvekkel összhangban vannak: EN 62841-1, EN ISO 12100, EN ISO 13857, EN ISO 13854, EN 28662-1, EN 61000-6-3, EN 61000-6-2, EN 60529, EN ISO 14118; és megfelelnek a rendeltetés szerinti 2006/42/EG, 2014/30/EU, 2011/65/EU irányelveknek.

(RO) CE-* - Declarație de conformitate. Noi declarăm pe propria răspundere că acest produs este în conformitate cu următoarele norme și documente normative: EN 62841-1, EN ISO 12100, EN ISO 13857, EN ISO 13854, EN 28662-1, EN 61000-6-3, EN 61000-6-2, EN 60529, EN ISO 14118; potrivit dispozițiilor directivelor 2006/42/EG, 2014/30/EU, 2011/65/EU

Remscheid, 22.02.2022



Joh. - Christoph Schütz

Dipl.-Ing. Joh.-Christoph Schütz, CE-Representative

*2016

Handgeführtes batteriebetriebenes Elektrowerkzeug Typ EKM60IDCFM

Klauke

- (D) CE-* - Konformitätserklärung RED. Wir erklären in alleiniger Verantwortlichkeit, daß dieses Produkt mit den folgenden Normen oder normativen Dokumenten übereinstimmt: EN IEC 62368-1, ETSI EN 301489-1, ETSI EN 301489-17, ETSI EN 300328 V2.2.2, EN 62479 gemäß den Bestimmungen der Richtlinien 2014/53/EU, 2011/65/EU
- (GB) CE-* - Declaration of conformity RED. We declare under our sole responsibility that this product is in conformity with the following standards or normative documents: EN IEC 62368-1, ETSI EN 301489-1, ETSI EN 301489-17, ETSI EN 300328 V2.2.2, EN 62479 in accordance with the regulations of directives 2014/53/EU, 2011/65/EU
- (F) CE-* - Déclaration de conformité RED. Nous déclarons sous notre seule responsabilité que ce produit est en conformité avec les normes ou documents normatifs suivants: EN IEC 62368-1, ETSI EN 301489-1, ETSI EN 301489-17, ETSI EN 300328 V2.2.2, EN 62479 conformément aux réglementations des directives 2014/53/EU, 2011/65/EU
- (E) CE-* - Declaración de conformidad RED. Declaramos bajo nuestra sola responsabilidad que este producto está en conformidad con las normas o documentos normativos siguientes: EN IEC 62368-1, ETSI EN 301489-1, ETSI EN 301489-17, ETSI EN 300328 V2.2.2, EN 62479 de acuerdo con las regulaciones de las directivas 2014/53/EU, 2011/65/EU
- (I) CE-* - Dichiarazione di conformità RED. Dichiariamo sotto la nostra esclusiva responsabilità che questo prodotto è conforme alle seguenti norme e documenti normativi: EN IEC 62368-1, ETSI EN 301489-1, ETSI EN 301489-17, ETSI EN 300328 V2.2.2, EN 62479 conformemente alle disposizioni delle direttive 2014/53/EU, 2011/65/EU
- (P) CE-* - Declaração de conformidade RED. Declaramos sob nossa exclusiva responsabilidade que este produto cumpre as seguintes normas ou documentos normativos: EN IEC 62368-1, ETSI EN 301489-1, ETSI EN 301489-17, ETSI EN 300328 V2.2.2, EN 62479 conforme as disposições das directivas 2014/53/EU, 2011/65/EU
- (NL) CE-* - Konformiteitsverklaring RED. Wij verklaren en wij stellen ons er alleen voor verantwoordelijk dat dit product voldoet aan de volgende normen of normatieve documenten: EN IEC 62368-1, ETSI EN 301489-1, ETSI EN 301489-17, ETSI EN 300328 V2.2.2, EN 62479 overeenkomstig de bepalingen van de richtlijnen 2014/53/EU, 2011/65/EU
- (GR) CE-* - ΔΗΛΩΣΗ ΣΥΜΜΟΡΦΩΣΗΣ M RED. ε αναλήψη συνολικής δηλώνουμε: ότι το πορον προϊόν συμφορει με τα παρακατω ποοντα και με τα ηροτινη ηου αναφοροντα στα σχετικο εγγραφα α EN IEC 62368-1, ETSI EN 301489-1, ETSI EN 301489-17, ETSI EN 300328 V2.2.2, EN 62479 συμφορα με τοχς κοινοισμοιου 2014/53/EU, 2011/65/EU
- (S) CE-* - Konformitetsdeklaration RED. Vi förklarar på eget ansvar att denna produkt överensstämmer med följande normer eller normativa dokument: EN IEC 62368-1, ETSI EN 301489-1, ETSI EN 301489-17, ETSI EN 300328 V2.2.2, EN 62479 enligt bestämmelserna i direktiverna 2014/53/EU, 2011/65/EU
- (DK) CE-* - Konformitetserklæring RED. Vi erklærer under almindeligt ansvar at dette produkt er i overensstemmelse med følgende normer eller normative dokumenter: EN IEC 62368-1, ETSI EN 301489-1, ETSI EN 301489-17, ETSI EN 300328 V2.2.2, EN 62479 i henhold til bestemmelserne i direktivene 2014/53/EU, 2011/65/EU
- (N) CE-* - Konformitetserklæring RED. Vi erklærer på eget ansvar at dette produkt er i overensstemmelse med følgende standarder eller standard-dokumenter: EN IEC 62368-1, ETSI EN 301489-1, ETSI EN 301489-17, ETSI EN 300328 V2.2.2, EN 62479 i henhold til bestemmelserne i direktive ne 2014/53/EU, 2011/65/EU
- (FIN) CE-* - Todistus standardin mukaisuudesta RED. Asiaasta vastaavana todistamme täten, että tämä tuote on seuraavien standardien ja standardoimisasiakirjojen vaatimusten mukainen: EN IEC 62368-1, ETSI EN 301489-1, ETSI EN 301489-17, ETSI EN 300328 V2.2.2, EN 62479 ja vastaa säädöksiä 2014/53/EU, 2011/65/EU
- (SK) CE-* - Prehľadzenie o zhode RED. Prehlasujeme na vlastnú zodpovednosť, že tieto produkty sú v súlade s nasledovnými normami: EN IEC 62368-1, ETSI EN 301489-1, ETSI EN 301489-17, ETSI EN 300328 V2.2.2, EN 62479 a v zhode so smernicami 2014/53/EU, 2011/65/EU
- (PL) CE-* - Zgodność z dyrektywami RED. Świadom odpowiedzialności oświadczamy, że niniejszy produkt jest zgodny z następującymi normami lub dokumentacja normatywna: EN IEC 62368-1, ETSI EN 301489-1, ETSI EN 301489-17, ETSI EN 300328 V2.2.2, EN 62479 zgodnie z postanowieniami wytycznych 2014/53/EU, 2011/65/EU
- (CZ) CE-* - Prohlášení o shodě RED. Prohlasujeme na vlastní zodpovědnost, že tyto produkty splňují následující normy nebo normativní listiny: EN IEC 62368-1, ETSI EN 301489-1, ETSI EN 301489-17, ETSI EN 300328 V2.2.2, EN 62479 Ve shodě se směrnicemi 2014/53/EU, 2011/65/EU
- (SLO) CE-* - Izjava o skladnosti RED. S tem potrjujemo splošno odgovornost, da je ta izdelek narejen v skladu z navedenimi normami in standardi EN IEC 62368-1, ETSI EN 301489-1, ETSI EN 301489-17, ETSI EN 300328 V2.2.2, EN 62479 ter dolobčami in smernicami 2014/53/EU, 2011/65/EU
- (HR) CE-* - Izjava o skladnosti RED. Pod punom odgovornošću izjavljujemo da je proizvod naveden u naslovu ovog dokumenta sukladan sa primijenjenim normama i normativnim dokumentima : EN IEC 62368-1, ETSI EN 301489-1, ETSI EN 301489-17, ETSI EN 300328 V2.2.2, EN 62479 u skladu sa odredbama preporuka 2014/53/EU, 2011/65/EU
- (H) CE-* - Megfelelőségi nyilatkozat RED. Kéziműködtetésű elektromos kéziszerszámok. Teljes felelősséggel kijelentjük, hogy ezek a termékek a következő szabványokkal és irányelvekkel összhangban vannak: EN IEC 62368-1, ETSI EN 301489-1, ETSI EN 301489-17, ETSI EN 300328 V2.2.2, EN 62479 és megfelelnek a rendeltetés 2014/53/EU, 2011/65/EU irányelveknek.
- (RO) CE-* - Declarație de conformitate RED. Noi declarăm pe propria răspundere că acest produs este în conformitate cu următoarele norme și documente normative: EN IEC 62368-1, ETSI EN 301489-1, ETSI EN 301489-17, ETSI EN 300328 V2.2.2, EN 62479 potrivit dispozițiilor directivelor 2014/53/EU, 2011/65/EU

Remscheid, 22.02.2022

CE 
Dipl.-Ing. Joh.-Christoph Schütz, CE-Representative

*2016

Handgeführtes batteriebetriebenes Elektrowerkzeug Typ EKM60IDCFM

(D) UKCA-* - Konformitätserklärung. Wir erklären in alleiniger Verantwortlichkeit, dass dieses Produkt mit den folgenden Normen oder normativen Dokumenten übereinstimmt: BS EN 62841-1, BS EN ISO 12100, BS EN ISO 13857, BS EN ISO 13854, BS EN 28662-1, BS EN 61000-6-3, BS EN 61000-6-2, BS EN ISO 14118 gemäß den Bestimmungen der Richtlinien 2006/42/EG, 2014/30/EU, 2011/65/EU
RED: BS EN IEC 62368-1, ETSI EN 301489-1, ETSI EN 301489-17, ETSI EN 300328 V2.2.2, BS EN 62479 gemäß den Bestimmungen der Richtlinien 2014/53/EU, 2011/65/EU

(GB) UKCA-* - Declaration of conformity. We declare under our sole responsibility that this product is in conformity with the following standards or normative documents: BS EN 62841-1, BS EN ISO 12100, BS EN ISO 13857, BS EN ISO 13854, BS EN 28662-1, BS EN 61000-6-3, BS EN 61000-6-2, BS EN ISO 14118 in accordance with the regulations of directives 2006/42/EG, 2014/30/EU, 2011/65/EU
RED: BS EN IEC 62368-1, ETSI EN 301489-1, ETSI EN 301489-17, ETSI EN 300328 V2.2.2, BS EN 62479 in accordance with the regulations of directives 2014/53/EU, 2011/65/EU

(F) UKCA-* - Déclaration de conformité. Nous déclarons sous notre seule responsabilité que ce produit est en conformité avec les normes ou documents normatifs suivants: BS EN 62841-1, BS EN ISO 12100, BS EN ISO 13857, BS EN ISO 13854, BS EN 28662-1, BS EN 61000-6-3, BS EN 61000-6-2, BS EN ISO 14118 conformément aux réglementations des directives 2006/42/EG, 2014/30/EU, 2011/65/EU
RED: BS EN IEC 62368-1, ETSI EN 301489-1, ETSI EN 301489-17, ETSI EN 300328 V2.2.2, BS EN 62479 conformément aux réglementations des directives 2014/53/EU, 2011/65/EU

(E) UKCA-* - Declaración de conformidad. Declaramos bajo nuestra sola responsabilidad que este producto está en conformidad con las normas o documentos normativos siguientes: BS EN 62841-1, BS EN ISO 12100, BS EN ISO 13857, BS EN ISO 13854, BS EN 28662-1, BS EN 61000-6-3, BS EN 61000-6-2, BS EN ISO 14118 de acuerdo con las regulaciones de las directivas 2006/42/EG, 2014/30/EU, 2011/65/EU
RED: BS EN IEC 62368-1, ETSI EN 301489-1, ETSI EN 301489-17, ETSI EN 300328 V2.2.2, BS EN 62479 de acuerdo con las regulaciones de las directivas 2014/53/EU, 2011/65/EU

(I) UKCA-* - Dichiarazione di conformità. Dichiariamo sotto la nostra esclusiva responsabilità che questo prodotto è conforme alle seguenti norme e documenti normativi: BS EN 62841-1, BS EN ISO 12100, BS EN ISO 13857, BS EN ISO 13854, BS EN 28662-1, BS EN 61000-6-3, BS EN 61000-6-2, BS EN ISO 14118 conformemente alle disposizioni delle direttive 2006/42/EG, 2014/30/EU, 2011/65/EU
RED: BS EN IEC 62368-1, ETSI EN 301489-1, ETSI EN 301489-17, ETSI EN 300328 V2.2.2, BS EN 62479 conformemente alle disposizioni delle direttive 2014/53/EU, 2011/65/EU

(P) UKCA-* - Declaração de conformidade. Declaramos sob nossa exclusiva responsabilidade que este produto cumpre as seguintes normas ou documentos normativos: BS EN 62841-1, BS EN ISO 12100, BS EN ISO 13857, BS EN ISO 13854, BS EN 28662-1, BS EN 61000-6-3, BS EN 61000-6-2, BS EN ISO 14118 conforme as disposições das directivas 2006/42/EG, 2014/30/EU, 2011/65/EU
RED: BS EN IEC 62368-1, ETSI EN 301489-1, ETSI EN 301489-17, ETSI EN 300328 V2.2.2, BS EN 62479 conforme as disposições das directivas 2014/53/EU, 2011/65/EU

(NL) UKCA-* - Konformiteitsverklaring. Wij verklaren en wij stellen ons er alleen voor verantwoordelijk dat dit product voldoet aan de volgende normen of normatieve documenten: BS EN 62841-1, BS EN ISO 12100, BS EN ISO 13857, BS EN ISO 13854, BS EN 28662-1, BS EN 61000-6-3, BS EN 61000-6-2, BS EN ISO 14118 overeenkomstig de bepalingen van de richtlijnen 2006/42/EG, 2014/30/EU, 2011/65/EU
RED: BS EN IEC 62368-1, ETSI EN 301489-1, ETSI EN 301489-17, ETSI EN 300328 V2.2.2, BS EN 62479 overeenkomstig de bepalingen van de richtlijnen 2014/53/EU, 2011/65/EU

(GR) UKCA-* - ΔΗΛΩΣΗ ΣΥΜΜΟΡΦΩΣΗΣ ΜΕ ε αναλυτή συνοπτικής δήλωσμοε: οτι το πορον προιον συμφωρει με τα παρωκωτα ποστοικα και με τα προτυπα ητοι αναφωρονται στα σχετικα εγγραφα BS EN 62841-1, BS EN ISO 12100, BS EN ISO 13857, BS EN ISO 13854, BS EN 28662-1, BS EN 61000-6-3, BS EN 61000-6-2, BS EN ISO 14118 συμφωρει με τοιχο κορονοτομοσ 2006/42/EG, 2014/30/EU, 2011/65/EU
RED: BS EN IEC 62368-1, ETSI EN 301489-1, ETSI EN 301489-17, ETSI EN 300328 V2.2.2, BS EN 62479 συμφωρει με τοιχο κορονοτομοσ 2014/53/EU, 2011/65/EU

(S) UKCA-* - Konformitetsdeklaration. Vi erklærer på eget ansvar at denne produkt overensstemmer med følgende normer eller normative dokumenter: BS EN 62841-1, BS EN ISO 12100, BS EN ISO 13857, BS EN ISO 13854, BS EN 28662-1, BS EN 61000-6-3, BS EN 61000-6-2, BS EN ISO 14118 enligt bestämmelserna i direktiverna 2006/42/EG, 2014/30/EU, 2011/65/EU
RED: BS EN IEC 62368-1, ETSI EN 301489-1, ETSI EN 301489-17, ETSI EN 300328 V2.2.2, BS EN 62479 enligt bestämmelserna i direktiverna 2014/53/EU, 2011/65/EU

(DK) UKCA-* - Konformitetserklæring. Vi erklærer under almindeligt ansvar at dette produkt er i overensstemmelse med følgende normer eller normative dokumenter: BS EN 62841-1, BS EN ISO 12100, BS EN ISO 13857, BS EN ISO 13854, BS EN 28662-1, BS EN 61000-6-3, BS EN 61000-6-2, BS EN ISO 14118 i henhold til bestemmelserne i direktiverna 2006/42/EG, 2014/30/EU, 2011/65/EU
RED: BS EN IEC 62368-1, ETSI EN 301489-1, ETSI EN 301489-17, ETSI EN 300328 V2.2.2, BS EN 62479 i henhold til bestemmelserne

*2021

i direktiverna 2014/53/EU, 2011/65/EU

(N) UKCA-* - Konformitetserklæring. Vi erklærer på eget ansvar at dette produkt er i overensstemmelse med følgende standarder eller standard-dokumenter: BS EN 62841-1, BS EN ISO 12100, BS EN ISO 13857, BS EN ISO 13854, BS EN 28662-1, BS EN 61000-6-3, BS EN 61000-6-2, BS EN ISO 14118 i henhold til bestemmelserne i direktivene nr 2006/42/EG, 2014/30/EU, 2011/65/EU
RED: BS EN IEC 62368-1, ETSI EN 301489-1, ETSI EN 301489-17, ETSI EN 300328 V2.2.2, BS EN 62479 i henhold til bestemmelserne i direktivene nr 2014/53/EU, 2011/65/EU

(FIN) UKCA-* - Todistus standardinmukaistusta. Asiasta vastaavana todistamme täten, että tämä tuote on seuraavien standardien ja standardomaisuuksien vaatimusten mukainen: BS EN 62841-1, BS EN ISO 12100, BS EN ISO 13857, BS EN ISO 13854, BS EN 28662-1, BS EN 61000-6-3, BS EN 61000-6-2, BS EN ISO 14118 ja vastaa säädöksiä 2006/42/EG, 2014/30/EU, 2011/65/EU
RED: BS EN IEC 62368-1, ETSI EN 301489-1, ETSI EN 301489-17, ETSI EN 300328 V2.2.2, BS EN 62479 ja vastaa säädöksiä 2014/53/EU, 2011/65/EU

(SK) UKCA-* - Prehľadzenie o zhode. Prehľadujeme na vlastnú zodpovednosť, že tieto produkty sú v súlade s nasledujúcimi normami: BS EN 62841-1, BS EN ISO 12100, BS EN ISO 13857, BS EN ISO 13854, BS EN 28662-1, BS EN 61000-6-3, BS EN 61000-6-2, BS EN ISO 14118 a v zhode so smernicami 2006/42/EG, 2014/30/EU, 2011/65/EU
RED: BS EN IEC 62368-1, ETSI EN 301489-1, ETSI EN 301489-17, ETSI EN 300328 V2.2.2, BS EN 62479 a v zhode so smernicami 2014/53/EU, 2011/65/EU

(PL) UKCA-* - Zgodność z dyrektywami UKCA. Świadomy odpowiedzialności oświadczamy, że niniejszy produkt jest zgodny z następującymi normami lub dokumentacją normatywną: BS EN 62841-1, BS EN ISO 12100, BS EN ISO 13857, BS EN 28662-1, BS EN 61000-6-3, BS EN 61000-6-2, BS EN ISO 14118 zgodnie z postanowieniami wytycznych 2006/42/EG, 2014/30/EU, 2011/65/EU
RED: BS EN IEC 62368-1, ETSI EN 301489-1, ETSI EN 301489-17, ETSI EN 300328 V2.2.2, BS EN 62479 zgodnie z postanowieniami wytycznych 2014/53/EU, 2011/65/EU

(CZ) UKCA-* - Prohlášení o shodě. Prohlášíme na vlastní zodpovědnost, že tyto produkty splňují následující normy nebo normativní listiny: BS EN 62841-1, BS EN ISO 12100, BS EN ISO 13857, BS EN ISO 13854, BS EN 28662-1, BS EN 61000-6-3, BS EN 61000-6-2, BS EN ISO 14118. Ve shodě se směrnicemi 2006/42/EG, 2014/30/EU, 2011/65/EU
RED: BS EN IEC 62368-1, ETSI EN 301489-1, ETSI EN 301489-17, ETSI EN 300328 V2.2.2, BS EN 62479. Ve shodě se směrnicemi 2014/53/EU, 2011/65/EU

(SLO) UKCA-* - Izjava o skladnosti. S tem potrjujemo splošno odgovornost, da je ta izdelek narejen v skladu z navedenimi normami in standardi: BS EN 62841-1, BS EN ISO 12100, BS EN ISO 13857, BS EN ISO 13854, BS EN 28662-1, BS EN 61000-6-3, BS EN 61000-6-2, BS EN ISO 14118 ter določbami in smernicami 2006/42/EG, 2014/30/EU, 2011/65/EU
RED: BS EN IEC 62368-1, ETSI EN 301489-1, ETSI EN 301489-17, ETSI EN 300328 V2.2.2, BS EN 62479 ter določbami in smernicami 2014/53/EU, 2011/65/EU

(HR) UKCA-* - Izjava o skladnosti. Pod punom odgovornošću izjavljujemo da je proizvod naveden u naslovu ovog dokumenta skladan sa primjenjenim normama i normativnim dokumentima: BS EN 62841-1, BS EN ISO 12100, BS EN ISO 13857, BS EN ISO 13854, BS EN 28662-1, BS EN 61000-6-3, BS EN 61000-6-2, BS EN ISO 14118 u skladu sa odredbama preporuka 2006/42/EG, 2014/30/EU, 2011/65/EU
RED: BS EN IEC 62368-1, ETSI EN 301489-1, ETSI EN 301489-17, ETSI EN 300328 V2.2.2, BS EN 62479 u skladu sa odredbama preporuka 2014/53/EU, 2011/65/EU

(H) UKCA-* - Megfelelőségi nyilatkozás. Kéziműködtetésű elektromos kéziszerszámok: Teljes felelősségű kijelentjük, hogy ezek a termékek a következő szabványokkal és irányelvekkel összhangban vannak: BS EN 62841-1, BS EN ISO 12100, BS EN ISO 13857, BS EN ISO 13854, BS EN 28662-1, BS EN 61000-6-3, BS EN 61000-6-2, BS EN ISO 14118; és megfelelnek a rendeltetés szerinti 2006/42/EG, 2014/30/EU, 2011/65/EU irányelveknek.
RED: BS EN IEC 62368-1, ETSI EN 301489-1, ETSI EN 301489-17, ETSI EN 300328 V2.2.2, BS EN 62479 és megfelelnek a rendeltetés 2014/53/EU, 2011/65/EU irányelveknek.

(RO) UKCA-* - Declarație de conformitate. Noi declarăm pe propria răspundere că acest produs este în conformitate cu următoarele norme și documente normative: BS EN 62841-1, BS EN ISO 12100, BS EN ISO 13857, BS EN ISO 13854, BS EN 28662-1, BS EN 61000-6-3, BS EN 61000-6-2, BS EN ISO 14118; potrivit dispozițiilor directivelor 2006/42/EG, 2014/30/EU, 2011/65/EU
RED: BS EN IEC 62368-1, ETSI EN 301489-1, ETSI EN 301489-17, ETSI EN 300328 V2.2.2, BS EN 62479 potrivit dispozițiilor directivelor 2014/53/EU, 2011/65/EU

Remscheid, 22.02.2022

UK CA
Klauke UK Ltd.
NR35 1JX

Joh. - Christoph Schütz
Dipl.-Ing. Joh. Christoph Schütz, CE-Representative