



[www.klauke.com](http://www.klauke.com)

# ESM 35ISM



Serialnumber

HE.18612\_A © 04/2019 R&D-2



Gustav Klauke GmbH • Auf dem Knapp 46 • D-42855 Remscheid • Telefon ++49 +2191-907-0 • Telefax ++49 +2191-907-141 • [www.klauke.com](http://www.klauke.com)

# Klauke®



Page



I

Bestimmungsgemäße Verwendung

Intended use

Vorhersehbare Fehlanwendung

Forseeable misuse

II - III

WORK



IV - IX

SERVICE



X - XII



XIII



ASC 1 - ASC 4



Wir freuen uns, dass Sie sich für ein Klauke Werkzeug entschieden haben und wünschen Ihnen viel Freude damit.

**2 Jahre  
Garantie**

**Weltweiter  
Werkzeug  
Service  
Klauke ASC**

Sie haben ein Qualitätsprodukt „Made in Germany“ erworben und erhalten 2 Jahre Garantie. Diese beginnt mit dem Kaufbelegdatum.

Um lange Freude und eine einwandfreie Funktion des Werkzeuges sicherzustellen, muss das Gerät spätestens beim Erreichen von 5.000 Arbeitsvorgängen oder nach 1 Jahr durch ein Autorisiertes Service Center (ASC) gewartet werden. Wird das Wartungsintervall von 5.000 Arbeitsvorgängen nicht eingehalten, erlischt der Garantieanspruch.

Im Rahmen dieser Wartung werden verschlissene Teile ersetzt und sicherheitsrelevante Teile geprüft und ggf. vorbeugend ersetzt.

Darüber hinaus empfehlen wir das Gerät jährlich zur Überprüfung an das zuständige ASC einzusenden.

Bediener müssen zum Arbeiten an Niederspannungsanlagen autorisiert und trainiert worden sein. Alle Werkzeuge müssen in Übereinstimmung mit örtlichen Sicherheitsregeln für das Arbeiten unter Spannung betrieben werden.

Für Fragen rund um unseren Werkzeugservice oder eine Frage zu einem bestimmten Anwendungsfall stehen wir Ihnen persönlich unter der kostenlosen Hotline 0800-4685528 zur Verfügung.



Ihr Klauke Team

Thank you for choosing a Klauke tool. We hope it gives you lots of pleasure.

**2 years  
Warranty**

**World wide  
Tool  
Service  
Klauke ASC**

You have purchased a quality product „Made in Germany“, which is covered by a 2 year warranty. The warranty commences from the purchase receipt date.

To ensure lasting enjoyment and a flawless tool function, the product must be serviced by an Authorised Service Center (ASC) after 5,000 operations or after 1 year. Should the service Interval exceed 5,000 cycles the warranty claim is void.

The Service includes predictive maintenance in which worn-out parts will be replaced and safety relevant parts checked/replaced.

We recommend to have the tools checked yearly through an Authorized Service Center (ASC).

All users must be authorized and trained for LV working. All tools must be used in accordance with local Live Line procedures.

If you have any questions about our tool service or about a specific application, please go to  
<http://www.klauke.com/en/service/tool-service/>



Your Klauke team



ESM 35ISM

Klauke®

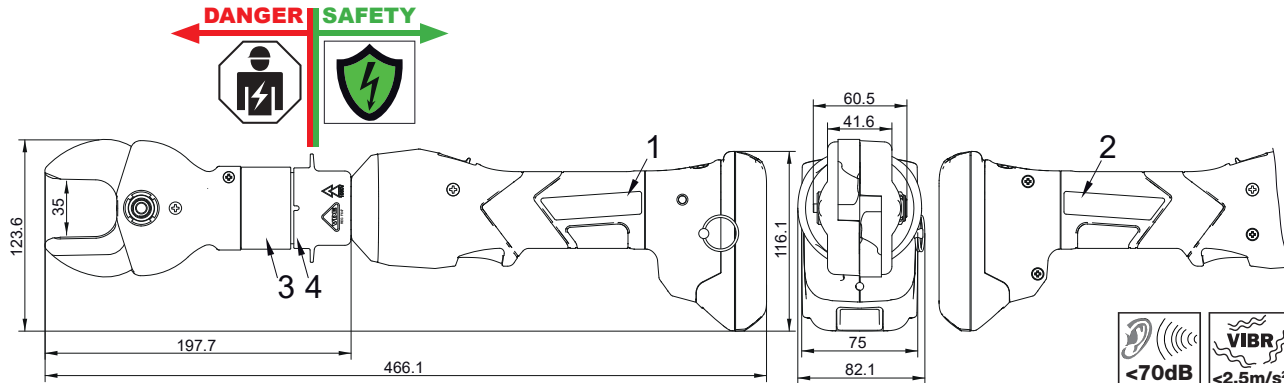

 <70dB	 VIBR <2,5m/s <sup>2</sup>
 +40°C -10°C	 Bio
 3,1 kg	 30 kN



**WARNING**

Read all safety warnings, instructions, illustrations and specifications provided with this power tool.

Failure to follow all instructions listed below may result in electric shock, fire and/or serious injury.

Save all warnings and instructions for future reference.





ESM 35ISM

Klauke®

### Bestimmungsgemäße Verwendung

Intended use



IEC  
60900



DANGER SAFETY



### Vorhersehbare Fehlanwendung

Foreseeable misuse

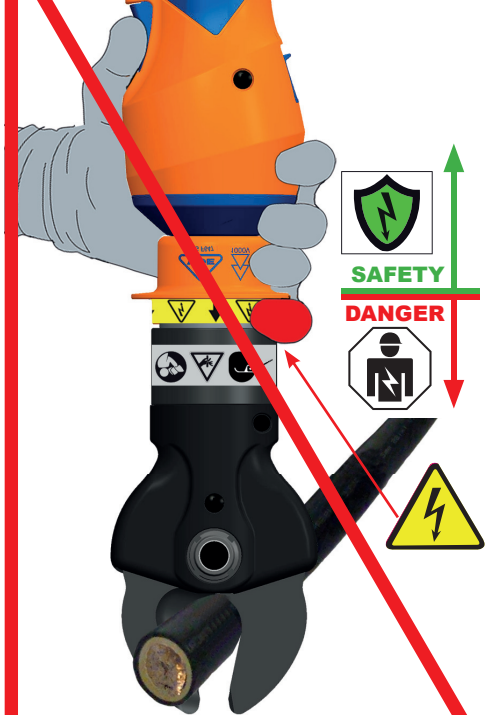

WORK



SERVICE



DON'T DO



General safety rules





IEC 60228

CL1,2,5&(6)



Bestimmungsgemäße Verwendung Intended use

Eindrähtiger Rundleiter cable CL1 - re	Mehrdrähtiger Rundleiter cable CL2 - rm	Verdichtet Mehrdrähtig cable CL2 - rmV compacted	
Freileitung (Aldrey) conductor CL2 - rm	Armierter Leiter, blecharmiert reinforced conductor, mild steel 1* weicher Stahl mild steel		



Vorhersehbare Fehlanwendung Forseeable misuse

Feinstdrähtig cable CL6 - F	ACSR	Armierter Leiter, stahlarmiert steel reinforced conductor	

IEC 60900



Bestimmungsgemäße Verwendung Intended use



Einleiterkabel Single core



Vorhersehbare Fehlanwendung Forseeable misuse



Mehrleiterkabel multicore cable

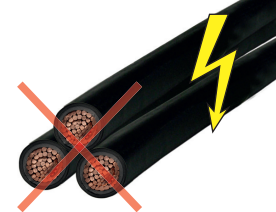



# Persönliche Schutzausrüstung Personal Protective Equipment

**PSA**  
**PPE**

## BEFORE WORK

Verwenden Sie PSA in Übereinstimmung mit örtlichen Arbeitsanweisungen!

Use PPE in line with local operating live working procedures!





**! WARNING**

**Allgemeine Regel:  
Behandeln Sie alle Kabel als wären Sie unter Spannung.**

**General rule:  
Always treat all cable as being live.**

**! WARNING**

**Verwenden Sie Werkzeuge ausschließlich in Übereinstimmung mit firmeneigenen Arbeitsanweisungen.**

**Use tool always in accordance with company procedures.**

**! WARNING**

**Werkzeugführer müssen von der Firma für die zu verrichtende Arbeit autorisiert sein.  
Users must be authorized for the work they do by the company.**

**! WARNING**

**Kein ATEX Werkzeug  
No ATEX tool**

**! WARNING**



**Schneiden Sie keine unter Spannung stehenden mehradrigen Kabel.  
Do not cut live multicore cables.**

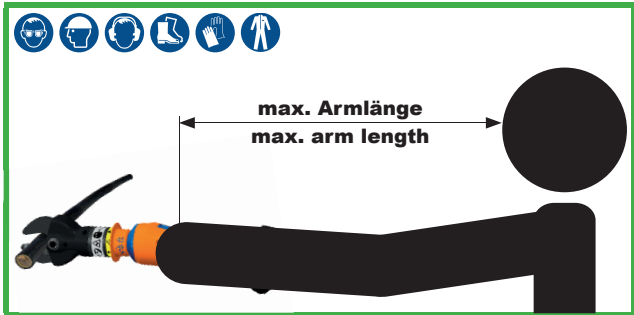





ESM 35ISM

Klauke®

**DANGER** **SAFETY**

AUTO  
 (QUICK STOP)  
 MAN  
 2K  
 IPS  
 SERVICE  
 ELECTRONIC  
 PDF  
 Display

19 year of manufacture  
 Energy Save  
 easy  
 LED  
 18V Li-Ion

BL1815 (RAL1)  
 Makita 18V

optional:  
 BL1850(B) (RAL4)  
 BL1840(B) (RAL0)  
 BL1830(B) (RAL2)

NG2  
 304711  
 PR  
 142  
 Klauke  
 Auf dem Krapp 46  
 D-42855  
 Remscheid

2 years Warranty  
 World wide Tool Service  
 ACHTUNG! Bei Beschädigung  
 ATTENTION! If broken links of Warranty  
 Garantiesiegel  
 Warranty seal

datecode  
 batch# e.g. 304711  
 datecode e.g. P = 2020; R = April  
 consecutive# e.g. „142“ =  
 tool # 142

Klauke ASC  
 Authorised Service Center

datecode					
Year	Code	Month	Code	Month	Code
2018	M	Jan.	N	July	V
2019	N	Feb.	P	Aug.	W
2020	P	Mar.	Q	Sept.	X
2021	Q	Apr.	R	Oct.	Y
2022	R	May	S	Nov.	Z
2023	S	June	T	Dec.	1

**WORK** **SERVICE** **DON'T DO** **DON'T DO** **General safety rules**



# ESM 35ISM

Use tool only with 18V Makita Battery



- BL1850(B) 45 min. RAL4
  - BL1840(B) 36 min. RAL40
  - BL1830(B) 22 min. RAL2
  - BL1815 15 min. RAL1
- 10 - 40°C



Alle Bedienungsanleitungen auch unter [www.klauke.de](http://www.klauke.de) abrufbar  
All manuals are also available on [www.klauke.com](http://www.klauke.com)

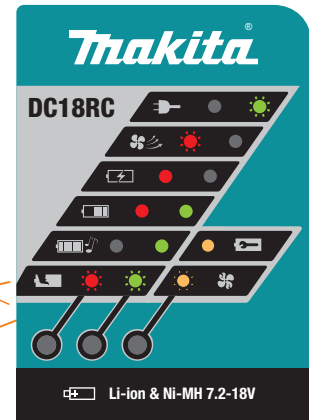



ESM 35ISM

Klauke®

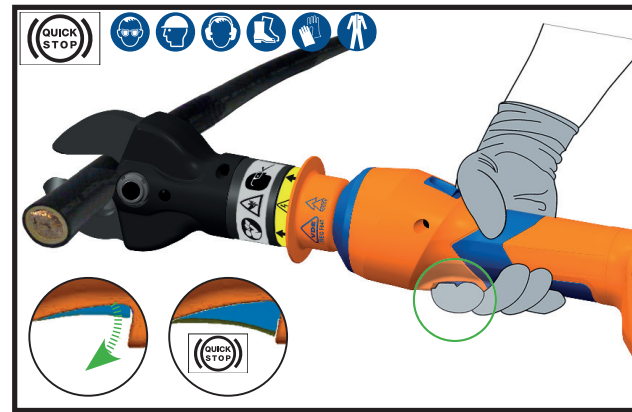
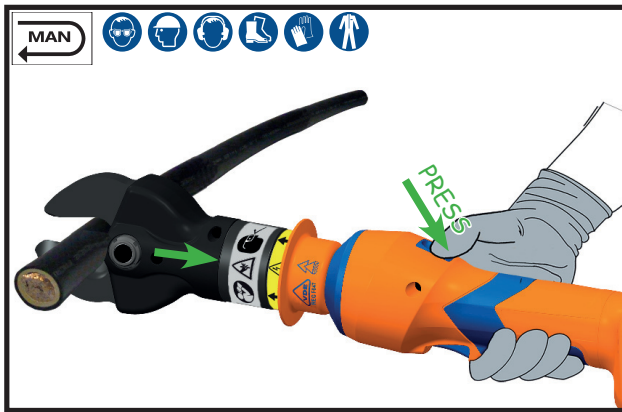
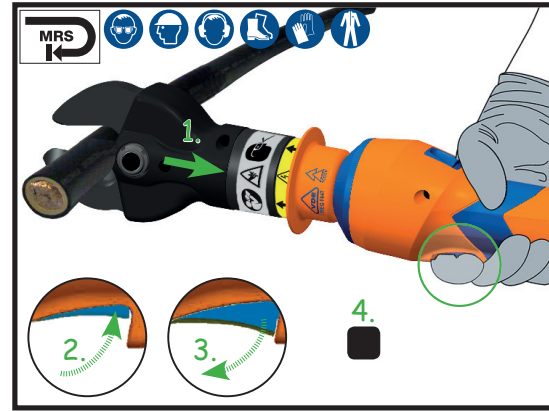
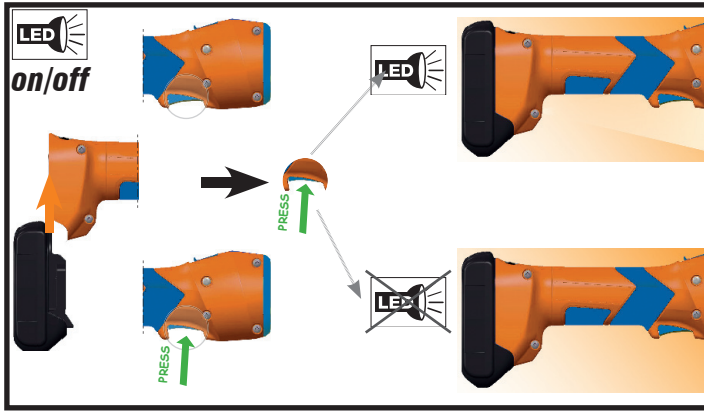

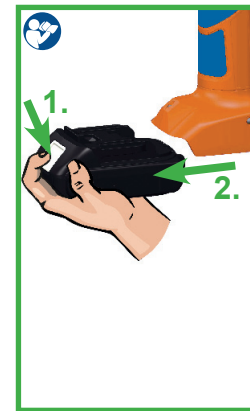
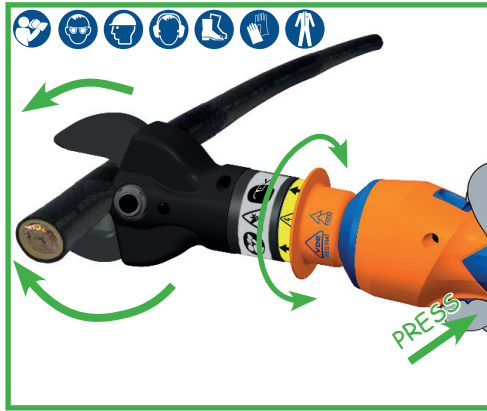



1		
2		<b>Klauke®</b>
	ERROR CODE: ****	Error code *1
3a		BT P 3 bar P 3 bar Bluetooth (if connected) Battery charging level Current pressure Pressure max. *2
3b		bar / psi to change: bar / psi
3c		bar / psi
3b		to change: kN / lbf
3d		BT F 74 lbf F 369 lbf
4a		USER 3: RD3 Doppelklick DoubleClick
4b		USER SELECT: RD3 Einfachklick Singleclick enter menu
4c		USER SELECT: RD3 Doppelklick DoubleClick select
4d		USER SELECT: RD3 Doppelklick DoubleClick confirmed
5		NEXT SERVICE: 9826 0Ps Cycles (until next service)
6		TOTAL: t = 0.07 h Q = 21.12 Ah n = 174 Since manufacturing: operating hours Capacity # crimps
7		<b>RETURN</b>

- \*1 Error codes:
- 1 Overcurrent fuse
  - 2 Overcurrent comparator
  - 3 Overheat board
  - 4 Overheat battery
  - 5 Battery empty, operation stop
  - 6 Faulty crimp motor in operation
  - 7 Faulty crimp motor not in operation
  - 8 Low battery
  - 9 Battery empty
  - 10 RTC battery low
  - 11 Tool deactivated
  - 12 Service necessary
  - 13 RTC not found
  - 14 BT unit not found
  - 16 Pressure sensor not found
  - 17 Burst pressure exceeded
  - 18 Battery temperature too low

- 1 Überstrom durch Überstromsicherung
- 2 Überstrom durch Komparator
- 3 Boardtemperatur zu hoch
- 4 Akkutemperatur zu hoch
- 5 Akkuspannung während der Operation zu gering
- 6 Fehlpressung bei laufendem Motor
- 7 Fehlpressung bei stehendem Motor
- 8 Niedrige Akkuspannung
- 9 Akku leer
- 10 RTC-Batterie leer
- 11 Werkzeug deaktiviert
- 12 Service nötig
- 13 RTC nicht verfügbar
- 14 BT-Modul nicht verfügbar
- 16 Drucksensor nicht verfügbar
- 17 Berstdruck überschritten
- 18 Akkutemperatur zu gering

\*2 (2Hz)





**BEFORE WORK**

>1000 V

DIN EN 50110

- 1.
- 2.
- 3.

once a year

**Klauke ASC**  
Authorised Service Center

1 year or 5.000 operations

**Klauke ASC**  
Authorised Service Center

OLD PART REPLACEMENT SAFETY NEW

2 years Warranty

World wide Tool Service

WEEE 2012/19/EU

Klauke-WEEE-Abholung@Emerson.com

2 years Warranty

World wide Tool Service









**Klauke ASC**

**Klauke ASC**  
Authorised Service Center

30% max.

**Klauke**

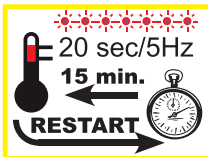

			<p>Wann/When/Quand/Quando/ cuándo/Wanneer/Когда/это происходит/Kiedy/quando</p>	<p>Warum/Why/Pourquoi/Porquê/ ¿por qué?/Waarom/Причина/ Dlaczego/Perché</p>
 20 sec			<p>nach Arbeitsvorgang after working cycle après opération de travail Después del proceso de trabajo após o processo de trabalho na bedrijfscyclus после цикла опрессовки po zakończeniu pracy dopo il processo di lavoro</p>	
 20 sec/2Hz			<p>nach Arbeitsvorgang after working cycle après opération de travail Después del proceso de trabajo após o processo de trabalho na bedrijfscyclus после цикла опрессовки po zakończeniu pracy dopo il processo di lavoro</p>	  <p><b>Klauke ASC®</b> Authorized Service Center</p>
 20 sec/5Hz			<p>während der Übertemperatur while exceeding the temp. limit pendant surchauffe en caso de temperatura excesiva durante a temperatura excessiva tijdens te hoge temperatuur при высокой температуре внутри корпуса przy przegrzaniu superando il limite di temperatura</p>	<p>Werkzeug zu heiß Unit too hot outil surchauffé Herramienta demasiado caliente ferramenta demasiado quente gereedschap te heet Перегрев инструмента urządzenie za gorące Utensile troppo caldo</p> 



# Handgeführtes batteriebetriebenes Elektrowerkzeug Typ **ESM 35ISM**

**Klauke**<sup>®</sup>

- (D)** CE-19 - Konformitätserklärung. Wir erklären in alleiniger Verantwortlichkeit, daß dieses Produkt mit den folgenden Normen oder normativen Dokumenten übereinstimmt: EN 62841-1, EN ISO 12100, EN ISO 13857, EN 349, EN 28662-1, EN 61000-6-3, EN 61000-6-2, EN 60529, EN 1037 gemäß den Bestimmungen der Richtlinien 2006/42/EG, 2014/30/EU, 2011/65/EU
- (GB)** CE-19 - Declaration of conformity. We declare under our sole responsibility that this product is in conformity with the following standards or normative documents: EN 62841-1, EN ISO 12100, EN ISO 13857, EN 349, EN 28662-1, EN 61000-6-3, EN 61000-6-2, EN 60529, EN 1037 in accordance with the regulations of directives 2006/42/EG, 2014/30/EU, 2011/65/EU
- (F)** CE-19 - Déclaration de conformité. Nous déclarons sous notre seule responsabilité que ce produit est en conformité avec les normes ou documents normatifs suivants: EN 62841-1, EN ISO 12100, EN ISO 13857, EN 349, EN 28662-1, EN 61000-6-3, EN 61000-6-2, EN 60529, EN 1037 conformément aux réglementations des directives 2006/42/EG, 2014/30/EU, 2011/65/EU
- (E)** CE-19 - Declaración de conformidad. Declaramos bajo nuestra sola responsabilidad que este producto está en conformidad con las normas o documentos normativos siguientes: EN 62841-1, EN ISO 12100, EN ISO 13857, EN 349, EN 28662-1, EN 61000-6-3, EN 61000-6-2, EN 60529, EN 1037 de acuerdo con las regulaciones de las directivas 2006/42/EG, 2014/30/EU, 2011/65/EU
- (I)** CE-19 - Dichiarazione di conformità. Dichiariamo sotto la nostra esclusiva responsabilità che questo prodotto è conforme alle seguenti norme e documenti normativi: EN 62841-1, EN ISO 12100, EN ISO 13857, EN 349, EN 28662-1, EN 61000-6-3, EN 61000-6-2, EN 60529, EN 1037 conformemente alle disposizioni delle direttive 2006/42/EG, 2014/30/EU, 2011/65/EU
- (P)** CE-19 - Declaração de conformidade. Declaramos sob nossa exclusiva responsabilidade que este produto cumpre as seguintes normas ou documentos normativos: EN 62841-1, EN ISO 12100, EN ISO 13857, EN 349, EN 28662-1, EN 61000-6-3, EN 61000-6-2, EN 60529, EN 1037 conforme as disposições das directivas 2006/42/EG, 2014/30/EU, 2011/65/EU
- (NL)** CE-19 - Konformiteitsverklaring. Wij verklaren en wij stellen ons er alleen voor verantwoordelijk dat dit product voldoet aan de volgende normen of normatieve documenten: EN 62841-1, EN ISO 12100, EN ISO 13857, EN 349, EN 28662-1, EN 61000-6-3, EN 61000-6-2, EN 60529, EN 1037 overeenkomstig de bepalingen van de richtlijnen 2006/42/EG, 2014/30/EU, 2011/65/EU
- (GR)** CE-19 - ΔΗΛΩΣΗ ΣΥΜΜΟΡΦΩΣΗΣ Με αναληψη συλλογικης δηλωνομε: οτι το πορον προιον συμφωνα με τα παρακατω ποστυπα και με τα ηρωτηα που αναφωρονται στα σχετικα εγγραφα. EN 62841-1, EN ISO 12100, EN ISO 13857, EN 349, EN 28662-1, EN 61000-6-3, EN 61000-6-2, EN 60529, EN 1037 συμφωνα με τοχς κοινοισμους 2006/42/EG, 2014/30/EU, 2011/65/EU
- (S)** CE-19 - Konformitetsdeklaration. Vi förklarar på eget ansvar att denna produkt överensstämmer med följande normer eller normativa dokument: EN 62841-1, EN ISO 12100, EN ISO 13857, EN 349, EN 28662-1, EN 61000-6-3, EN 61000-6-2, EN 60529, EN 1037 enligt bestämmelserna i direktiverna 2006/42/EG, 2014/30/EU, 2011/65/EU
- (DK)** CE-19 - Konformitetserklæring. Vi erklærer under almindeligt ansvar at dette produkt er i overensstemmelse med følgende normer eller normative dokumenter: EN 62841-1, EN ISO 12100, EN ISO 13857, EN 349, EN 28662-1, EN 61000-6-3, EN 61000-6-2, EN 60529, EN 1037 i henhold til bestemmelserne i direktiverne 2006/42/EØF, 2014/30/EU, 2011/65/EU
- (N)** CE-19 - Konformitetserklæring. Vi erklærer på eget ansvarlighet at dette produkt er i overensstemmelse med følgende standarder eller standard-dokumenter: EN 62841-1, EN ISO 12100, EN ISO 13857, EN 349, EN 28662-1, EN 61000-6-3, EN 61000-6-2, EN 60529, EN 1037 i henhold til bestemmelserne i direktive ne 2006/42/EØF, 2014/30/EU, 2011/65/EU
- (FIN)** CE-19 - Todistus standardinmukaissuudesta. Asiaasta vastaavana todistamme täten, että tämä tuote on seuraavien standardien ja standardoimisasiakirjojen vaatimusten mukainen: EN 62841-1, EN ISO 12100, EN ISO 13857, EN 349, EN 28662-1, EN 61000-6-3, EN 61000-6-2, EN 60529, EN 1037 ja vastaa säädöksiä 2006/42/EG, 2014/30/EU, 2011/65/EU
- (SK)** CE-19 - Prehlásenie o zhode. Prehlasujeme na vlastnú zodpovednosť, že tieto produkty sú v súlade s nasledovnými normami: EN 62841-1, EN ISO 12100, EN ISO 13857, EN 349, EN 28662-1, EN 61000-6-3, EN 61000-6-2, EN 60529, EN 1037 a v zhode so smernicami 2006/42/EG, 2014/30/EU, 2011/65/EU
- (PL)** CE-19 - Zgodność z dyrektywami CE. Świadomy odpowiedzialności oświadczamy, że niniejszy produkt jest zgodny z następującymi normami lub dokumentacją normatywną: EN 62841-1, EN ISO 12100, EN ISO 13857, EN 349, EN 28662-1, EN 61000-6-3, EN 61000-6-2, EN 60529, EN 1037 zgodnie z postanowieniami wytycznych 2006/42/EG, 2014/30/EU, 2011/65/EU
- (CZ)** CE-19 - Prohlášení o shode. Prohlasujeme na vlastní zodpovednosť, že tyto produkty splňují následující normy nebo normativní listiny: EN 62841-1, EN ISO 12100, EN ISO 13857, EN 349, EN 28662-1, EN 61000-6-3, EN 61000-6-2, EN 60529, EN 1037; Ve shode se smernicami 2006/42/EG, 2014/30/EU, 2011/65/EU
- (SLO)** CE-19 - Izjava o skladnosti. S tem potrjujemo splošno odgovornost, da je ta izdelek narejen v skladu z navedenimi normami in standardi: EN 62841-1, EN ISO 12100, EN ISO 13857, EN 349, EN 28662-1, EN 61000-6-3, EN 61000-6-2, EN 60529, EN 1037 ter določbami in smernicami 2006/42/EG, 2014/30/EU, 2011/65/EU
- (HR)** CE-19 - Izjava o skladnosti. Pod punom odgovornošću izjavljujemo da je proizvod naveden u naslovu ovog dokumenta sukladan sa primijenjenim normama i normativnim dokumentima : EN 62841-1, EN ISO 12100, EN ISO 13857, EN 349, EN 28662-1, EN 61000-6-3, EN 61000-6-2, EN 60529, EN 1037 u skladu sa odredbama preporuka 2006/42/EG, 2014/30/EU, 2011/65/EU
- (H)** CE-19 – Megfelelőeségi nyilatkozat. Kéziműkötetési elektromos kéziszerszámok: Teljes felelősséggel kijelentjük, hogy ezek a termékek a következő szabványokkal és irányelvekkel összhangban vannak: EN 62841-1, EN ISO 12100, EN ISO 13857, EN 349, EN 28662-1, EN 61000-6-3, EN 61000-6-2, EN 60529, EN 1037; és megfelelnek a rendeltetés szerinti 2006/42/EG, 2014/30/EU, 2011/65/EU irányelveknek.
- (RO)** CE-19 - Declarație de conformitate. Noi declarăm pe propria răspundere că acest produs este în conformitate cu următoarele norme și documente normative: EN 62841-1, EN ISO 12100, EN ISO 13857, EN 349, EN 28662-1, EN 61000-6-3, EN 61000-6-2, EN 60529, EN 1037; potrivit dispozițiilor directivelor 2006/42/EG, 2014/30/EU, 2011/65/EU

Remscheid, den 08.04.2019



Joh. - Christoph Schütz

Dipl.-Ing. Joh.-Christoph Schütz, CE-Beauftragter