



www.klauke.com

BTC3



ES 32RMCCFM



Serialnumber

HE.17772_E © 08/2017 R&D-2



Gustav Klauke GmbH • Auf dem Knapp 46 • D-42855 Remscheid • Telefon +49 2191 907 0 • www.klauke.com

Klauke

EMERSON

Wir freuen uns, dass Sie sich für ein Klauke Werkzeug entschieden haben und wünschen Ihnen viel Freude damit.



Sie haben ein Qualitätsprodukt „Made in Germany“ erworben und erhalten 2 Jahre Garantie. Diese beginnt mit dem Kaufbelegdatum.

Um lange Freude und eine einwandfreie Funktion des Werkzeuges sicherzustellen, muss das Gerät spätestens beim Erreichen von 10.000 Arbeitsvorgängen oder nach 3 Jahren durch ein Autorisiertes Service Center (ASC) gewartet werden. Wird das Wartungsintervall von 10.000 Arbeitsvorgängen nicht eingehalten, erlischt der Garantieanspruch.

Im Rahmen dieser Wartung werden verschlissene Teile ersetzt und sicherheitsrelevante Teile geprüft und ggf. vorbeugend ersetzt.

Darüber hinaus empfehlen wir das Gerät jährlich zur Überprüfung an das zuständige ASC einzusenden.

Für Fragen rund um unseren Werkzeugservice oder eine Frage zu einem bestimmten Anwendungsfall stehen wir Ihnen persönlich unter der kostenlosen 0800-4685528 zur Verfügung.



Ihr Klauke Team

Thank you for choosing a Klauke tool. We hope it gives you lots of pleasure.



You have purchased a quality product „Made in Germany“, which is covered by a 2 year warranty. The warranty commences from the purchase receipt date.

To ensure lasting enjoyment and a flawless tool function, the product must be serviced by an Authorized Service Center (ASC) after 10,000 operations or after 3 years. Should the service Interval exceed 10.000 cycles the warranty claim is void.

The Service includes predictive maintenance in which worn-out parts will be replaced and safety relevant parts checked/replaced.

We recommend to have the tools checked yearly through an Authorized Service Center (ASC).

If you have any questions about our tool service or about a specific application, please go to <http://www.klauke.com/en/support/tool-service/>



Your Klauke team



ES 32RMCCFM



optional:
 BL1850(B) (RAL4)
 BL1840(B) (RAL40)
 BL1830(B) (RAL2)

18v Li-Ion

IPS
SERVICE
PDF
LED

ACHTUNG! Scherengefahr! Caution: Sharp Blades!

AUTO **(QUICK STOP)** **MAN**

Remove battery before removing yellow cover!
Keep away from cutting head!
Remote - controlled tool
ATTENTION

ES32E

ES32E

2K

Energy Save

easy

REAL TIME

LED

Bluetooth

NG2

BL1815 (RAL1)

2 years Warranty

World wide Tool Service

Garantiesiegel
Bei Beschädigung
Garantieverlust!
Warranty seal
If broken loss of Warranty

datecode

Year	Code	Month	Code	Month	Code
2018	M	Jan.	N	July	V
2019	N	Feb.	P	Aug.	W
2020	P	Mar.	Q	Sept.	X
2021	Q	Apr.	R	Oct.	Y
2022	R	May	S	Nov.	Z
2023	S	June	T	Dec.	1

FCC ID: RFRMS42 • IC: 4957A-MS42
Model: CFM
 This device complies with Part 15 of the FCC Rules and with Industry Canada licence-exempt RSS standard(s). Operation is subject to the following two conditions: (1) this device may not cause harmful interference, and (2) this device must accept any interference received, including interference that may cause undesired operation.
 HE18055_D

batch# e.g. 304711
datecode e.g. P = 2020; R = April
consecutive# e.g. „142“ = tool # 142

304711
PR
142

Klauke
 Auf dem Knapp 46
 ☒ D-42855
 Remscheid

WORK **SERVICE** **DON'T DO** **General safety rules**



ES 32RMCCFM

Klauke

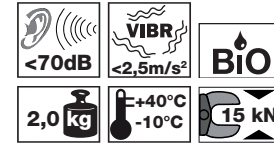
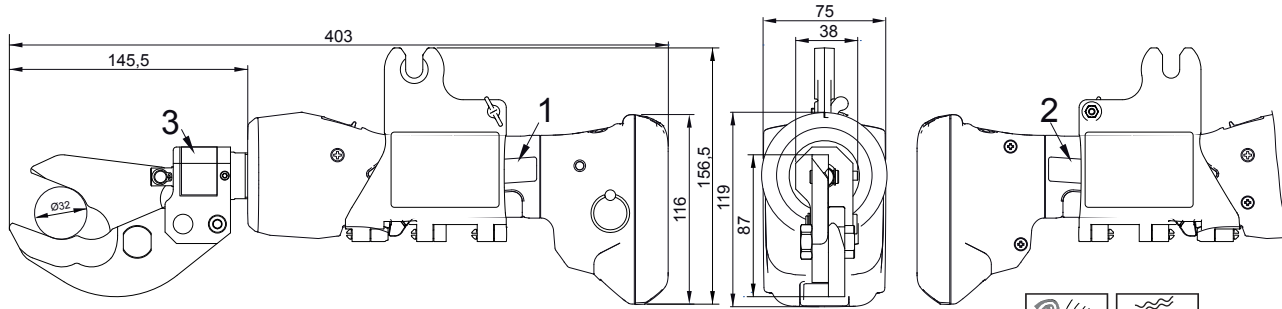

WARNING

Read all safety warnings, instructions, illustrations and specifications provided with this power tool.

Failure to follow all instructions listed below may result in electric shock, fire and/or serious injury.

Save all warnings and instructions for future reference.





ES 32RMCCFM

Use tool only with 18V Makita Battery



Makita BL1840 IEC61950
18V ~ 4.0Ah 72Wh

Makita Corporation 603992-6

Makita BL1850 IEC61950
18V ~ 5.0Ah 90Wh

Makita Corporation 603993-6

Makita Li-ion
BL1830 18V ~ 3.0Ah 54Wh

Makita Corporation 610964-1
Made in Japan

Makita Li-ion
BL1815 18V ~ 24Wh

Makita Corporation 616334-1
Made in Japan

- BL1850(B) 45 min.
RAL4
- BL1840(B) 36 min.
RAL40
- BL1830(B) 22 min.
RAL2
- BL1815 15 min.
RAL1
- 10 - 40°C



Makita
DC18RC

Li-ion & Ni-MH 7.2-18V

Makita DC18RC T
Prim.: 220V ~ 240V ~ 240W 50 ~ 60Hz
Sek.: 7.2V ~ 18V ~ 9A
0505611

CH.P/N: 630718-5
Makita Corporation 693950-6



Alle Bedienungsanleitungen auch unter www.klauke.de abrufbar
All manuals are also available on www.klauke.com





ES 32



CL1,2&(5)



Bestimmungsgemäße Verwendung Intended use



Eindrähtiger
Rundleiter

cablE CL1 - re

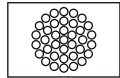

Freileitung
(Aldrey)

conductor CL2 - rm

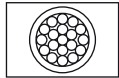

Mehrdrähtiger
Rundleiter

cablE CL2 - rm



Verdichtet
Mehrdrähtig

cablE CL2 - rm/V
compacted



Vorhersehbare Fehlanwendung Foreseeable misuse

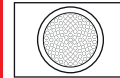

Feindrähtig

cablE CL5 - F

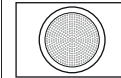

Feinstdrähtig

cablE CL6 - F

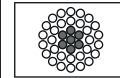

ACSR

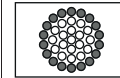

Armierter Leiter

reinforced
conductor

$\angle > 330^\circ$

Authorized Service Center

30% max.



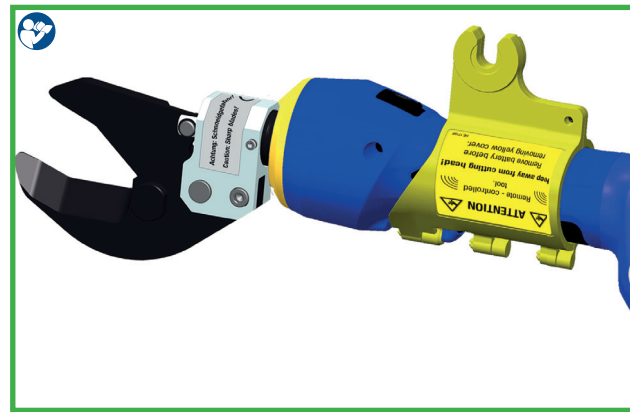
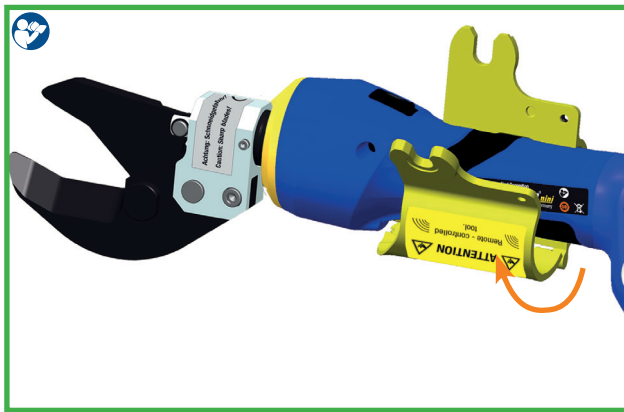
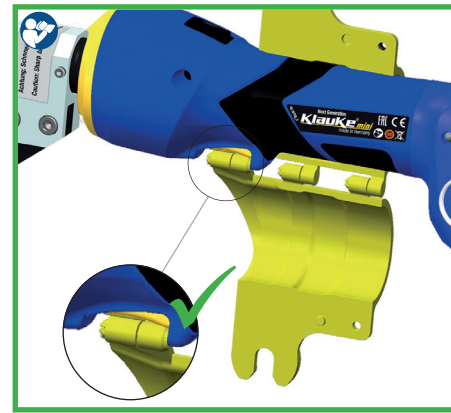

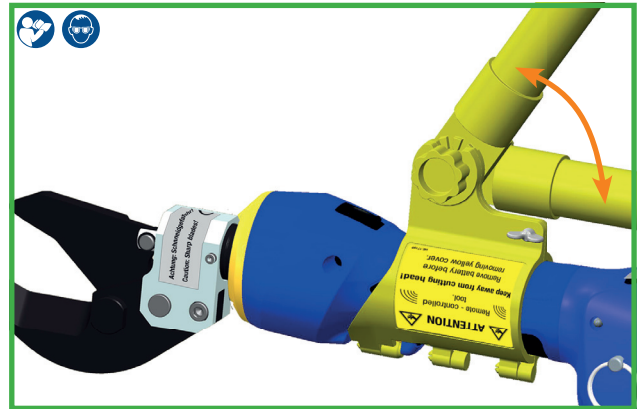
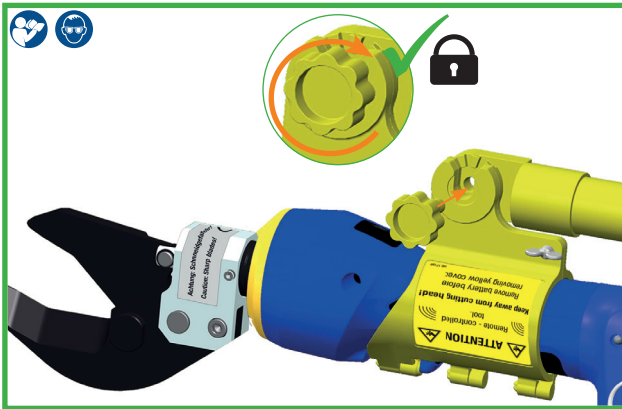



Klauke

BTC3

PRESS

CLICK

RC PAIRING
Keep Trigger pressed ...

RC PAIRING
RC SEARCH
Press Button on remote!

RC PAIRING
RC SEARCH
Auto Shutoff in 14:54 min. *

WORK

CUT

DISPLAY			
RC PAIRING	after 10:00 min.		
auto shutoff in 14:59 min.	after 13:30 min.		
RC CONNECTED	after 25:00 min.		
auto shutoff in 27:59 min.	after 28:30 min.		

BTC3

FOUND REMOTE
BOZ2sPo0
Connect?
Yes Next

FOUND REMOTE
BOZ2sPo0
Connect?
Yes Next

BOZ2sPo0

BTC3

FOUND REMOTE
BOZ2sPo0
Connect?
Yes Next

FOUND REMOTE
BOZ2sPo0
Connect?
Yes Next

BOZ2sPo0

AKE6rFa8

FOUND REMOTE
BOZ2sPo0
Connect?
Yes Next

RC CONNECTING
Connecting to BOZ2sPo0

RC CONNECTED
BOZ2sPo0
Auto Shutoff in 27:57 min. *

WORK

CUT

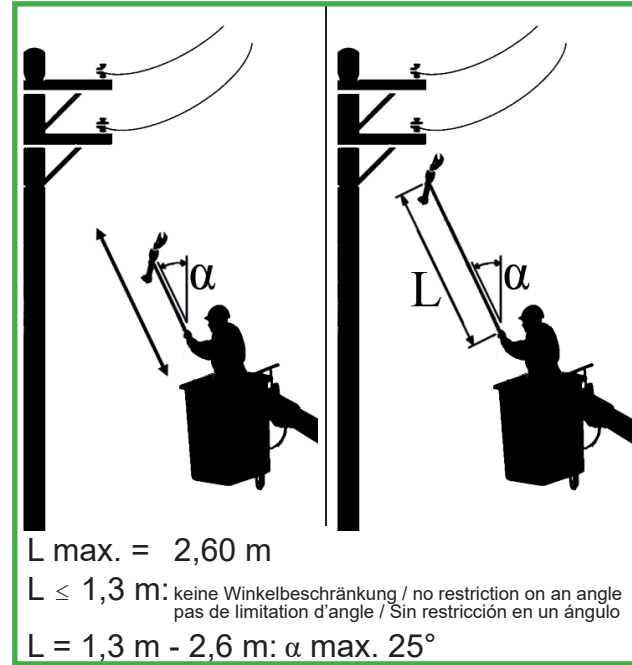
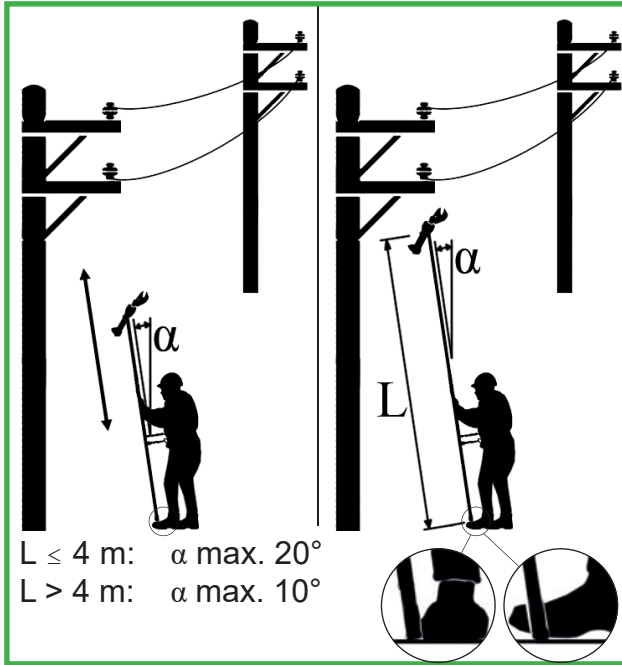

Achtung

Der Vorgesetzte muss die Arbeiten an geeignetes Personal vergeben, das über die nötige körperliche Kraft und das nötige Bewusstsein für den Umgang mit dem Glasfaserstab verfügt.



Attention

Supervisor has to dedicate the jobs to suitable personnel with the adequate physical strength and awareness to handle the fibre-glass stick operations.



Attention

Le superviseur doit confier le travail à du personnel approprié qui possède la force physique et la conscience nécessaires pour manipuler la tige de fibre de verre.



Atención

El supervisor debe asignar el trabajo a personal competente que tenga la fuerza física necesaria y el conocimiento adecuado para el manejo de la varilla de fibra de vidrio





ES 32RMCCFM

Klauke



Cu
Al

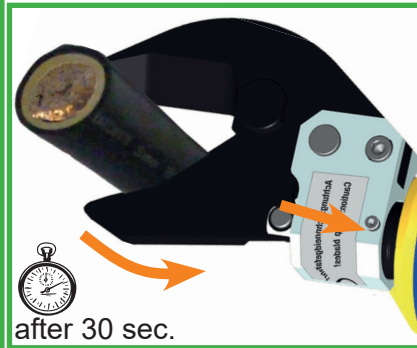
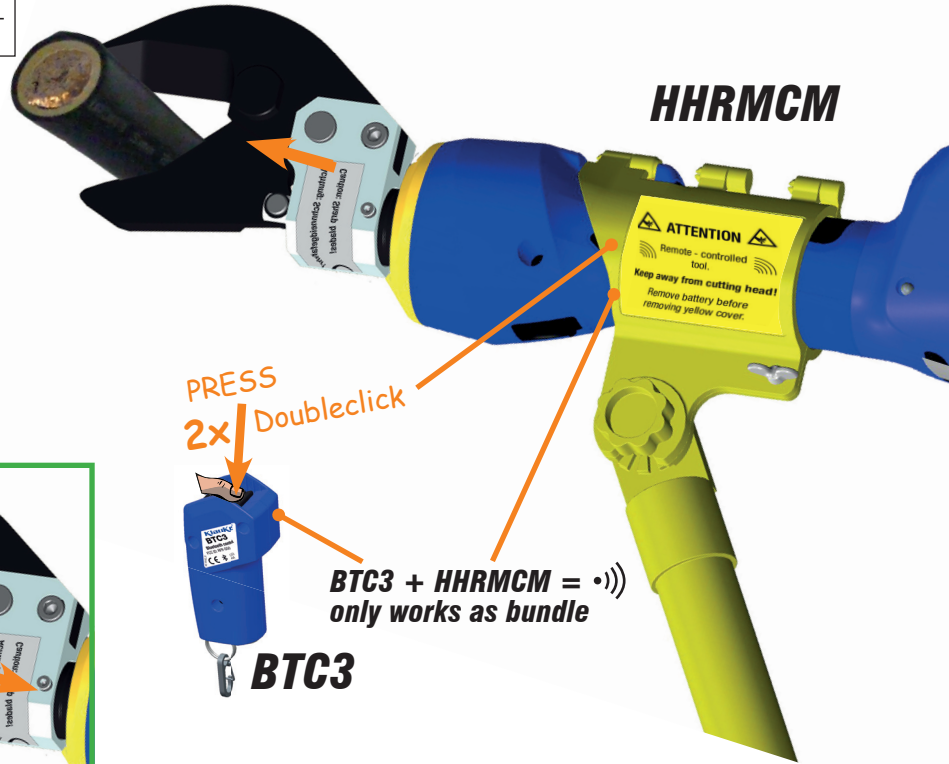

HE.17772_E © 08/2017

WORK



SERVICE



DON'T DO



General safety rules



IX



* Abb. ähnlich/pic. similar/Similaires

HE.17772_E © 08/2017





Operator: DIN EN 50110

Tab. A.1 - Guidance for distances D_L und D_V

Nominal system voltage	Minimum acceptable distance in air defining the outer limit of the live working zone	Minimum acceptable distance in air defining the outer limit of the vicinity zone
U_N [kV] r.m.s.	D_L [mm]	D_V [mm]
≤ 1	no contact	300
3	60	1 120
6	90	1 120
10	120	1 150
15	160	1 160
20	220	1 220
30	320	1 320
36	380	1 380
45	480	1 480
60	630	1 630
70	750	1 750
110	1 000	2 000
132	1 100	3 000
150	1 200	3 000
220	1 600	3 000
275	1 900	4 000
380	2 500	4 000
480	3 200	6 100
700	5 300	8 400

The figures of D_L and D_V have been set out to be a set of minimum administrative values, with respect to those existing in European countries.

Up to 70 kV; a wide range of values exists for D_L , because ergonomic considerations prevail on the calculation of the electrical component.

Consequently, the lowest value among the set of European figures is picked up.

Above 70 kV; the electrical component becomes predominant.

Accordingly, the minimum values of D_L given in Table A.1 are confirmed by computation method of EN 61472.

In the absence of computation methods for DC-systems, the values for distance D_L and D_V for AC-systems could also be used for DC-systems up to 70 kV.

NOTE 1 Intermediate values for D_L and D_V may be determined by linear interpolation.

NOTE 2 The values of Table A.1 intend to give guidance for future harmonisation between countries. Nevertheless, lower values can be accepted temporarily.

Bystanders: DL = 10 m

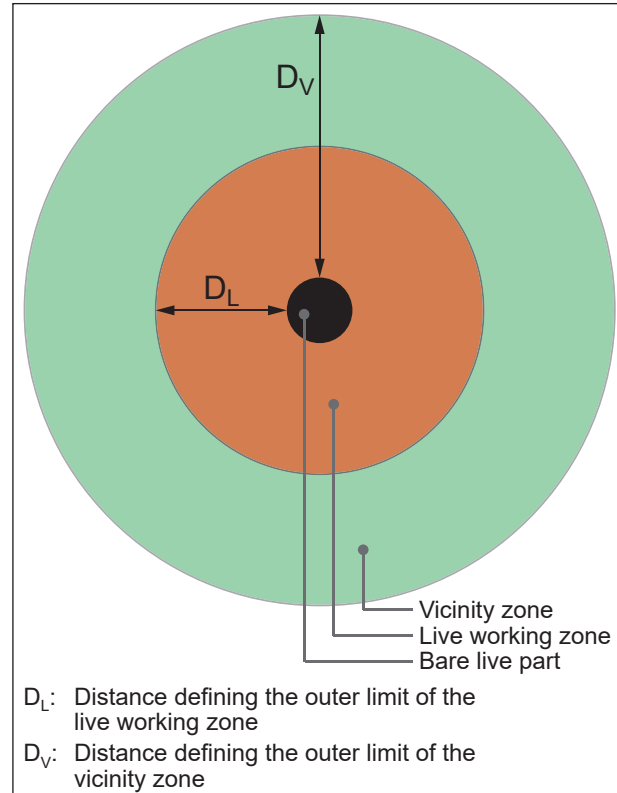

picture 1 - Distances in air and zones for work





1. Risk assessment
2.  see General Safety Instructions for Live-line Working



* Abb. ähnlich/pic. similar/Similaires







1			
2		Klauke	
		ERROR CODE: ****	Error code *1
3		BT	Bluetooth (if connected) Battery charging level *2
4a		CURRENT USER: 1 REMOTE CONTROL	initial settings:
4b		USER SELECT: 1 REMOTE CONTROL	to change:
4c		CURRENT USER: 2 DOUBLE CLICK	
4d		CURRENT USER: 2 DOUBLE CLICK	current user confirmed additional profiles: 1: remote control (double click) 2-5: double click
5		NEXT SERVICE: 9826 0P _s	Cycles (until next service)
6		TOTAL: t = 0.07 h Q = 21.12 Ah n = 174	Since manufacturing: operating hours Capacity # crimps
7		RETURN	

- *1 Error codes:
- 1 Overcurrent fuse
 - 2 Overcurrent comparator
 - 3 Overheat board
 - 4 Overheat battery
 - 5 Battery empty, operation stop
 - 6 Faulty crimp motor in operation
 - 7 Faulty crimp motor not in operation
 - 8 Low battery
 - 9 Battery empty
 - 10 RTC battery low
 - 11 Tool deactivated
 - 12 Service necessary
 - 13 RTC not found
 - 14 BT unit not found
 - 16 Pressure sensor not found
 - 17 Burst pressure exceeded
 - 18 Battery temperature too low
 - 21 Fernbedienung batterie schwach

- 1 Überstrom durch Überstromsicherung
- 2 Überstrom durch Komparator
- 3 Boardtemperatur zu hoch
- 4 Akkuteperatur zu hoch
- 5 Akkuspannung während der Operation zu gering
- 6 Fehlpressung bei laufendem Motor
- 7 Fehlpressung bei stehendem Motor
- 8 Niedrige Akkuspannung
- 9 Akku leer
- 10 RTC-Batterie leer
- 11 Werkzeug deaktiviert
- 12 Service nötig
- 13 RTC nicht verfügbar
- 14 BT-Modul nicht verfügbar
- 16 Drucksensor nicht verfügbar
- 17 Berstdruck überschritten
- 18 Akkuteperatur zu gering
- 21 remote control battery low

*2 (2Hz)





Klauke i-press® Software

▶ www.klauke.com/connectivity

Klauke i-press® App

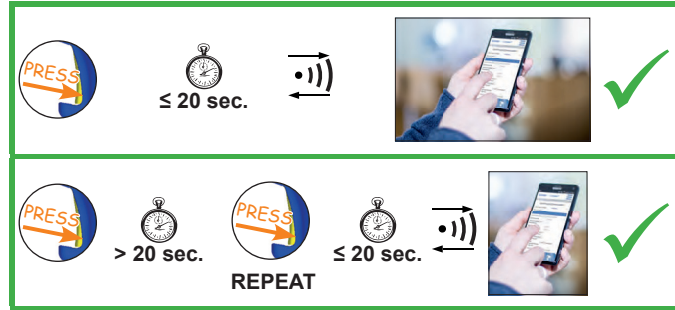

Le présent appareil est conforme aux CNR d'Industrie Canada applicables aux appareils radio exempts de licence. L'exploitation est autorisée aux deux conditions suivantes:

- (1) l'appareil ne doit pas produire de brouillage, et
- (2) l'utilisateur de l'appareil doit accepter tout brouillage radioélectrique subi, même si le brouillage est susceptible d'en compromettre le fonctionnement.

NOTICE:

Changes or modifications made to this equipment not expressly approved by Klauke may void the FCC authorization to operate this equipment.





ES 32RMCCFM

Klauke

BEFORE WORK

DIN EN 50110

2 years Warranty
World wide Tool Service
Klauke ASC

- 1.
- 2.
- 3.

Klauke

once a year

Recommendation
Empfehlung

Klauke ASC
Authorised Service Center

3 years or 10.000 operations

Klauke ASC
Authorised Service Center

2 years Warranty
World wide Tool Service
Klauke ASC

WEEE 2012/19/EU

klauke-weee-abholung@emerson.com

Klauke ASC
Authorised Service Center



			Wann/When/Quand/Quando/ cuándo/Wanneer/Когда/это происходит/Kiedy/quando	Warum/Why/Pourquoi/Porquê/ ¿por qué?/Waarom/Причина/ Dlaczego/Perché
 20 sec			nach Arbeitsvorgang after working cycle après opération de travail Después del proceso de trabajo após o processo de trabalho na bedrijfscyclus после цикла опрессовки po zakończeniu pracy dopo il processo di lavoro	
 20 sec/2Hz			nach Arbeitsvorgang after working cycle après opération de travail Después del proceso de trabajo após o processo de trabalho na bedrijfscyclus после цикла опрессовки po zakończeniu pracy dopo il processo di lavoro	Klauke ASC Authorized Service Center
 20 sec/5Hz			während der Übertemperatur while exceeding the temp. limit pendant surchauffe en caso de temperatura excesiva durante a temperatura excessiva tijdens te hoge temperatuur при высокой температуре внутри корпуса przy przegrzaniu superando il limite di temperatura	Werkzeug zu heiß Unit too hot outil surchauffé Herramienta demasiado caliente ferramenta demasiado quente gereedschap te heet Перегрев инструмента urządzenie za gorące Utensile troppo caldo



Handgeführtes batteriebetriebenes Elektrowerkzeug Typ ES 32RMCCFM

Klauke

(D) CE-'17 - Konformitätserklärung. Wir erklären in alleiniger Verantwortlichkeit, daß dieses Produkt mit den folgenden Normen oder normativen Dokumenten übereinstimmt: EN 62841-1, EN ISO 12100, EN ISO 13857, EN 349, EN 28662-1, EN 61000-6-3, EN 61000-6-2, EN 60529, EN 1037 gemäß den Bestimmungen der Richtlinien 2006/42/EG, 2014/30/EU, 2011/65/EU

(GB) CE-'17 - Declaration of conformity. We declare under our sole responsibility that this product is in conformity with the following standards or normative documents: EN 62841-1, EN ISO 12100, EN ISO 13857, EN 349, EN 28662-1, EN 61000-6-3, EN 61000-6-2, EN 60529, EN 1037 in accordance with the regulations of directives 2006/42/EG, 2014/30/EU, 2011/65/EU

(F) CE-'17 - Déclaration de conformité. Nous déclarons sous notre seule responsabilité que ce produit est en conformité avec les normes ou documents normatifs suivants: EN 62841-1, EN ISO 12100, EN ISO 13857, EN 349, EN 28662-1, EN 61000-6-3, EN 61000-6-2, EN 60529, EN 1037 conformément aux réglementations des directives 2006/42/EG, 2014/30/EU, 2011/65/EU

(E) CE-'17 - Declaración de conformidad. Declaramos bajo nuestra sola responsabilidad que este producto está en conformidad con las normas o documentos normativos siguientes: EN 62841-1, EN ISO 12100, EN ISO 13857, EN 349, EN 28662-1, EN 61000-6-3, EN 61000-6-2, EN 60529, EN 1037 de acuerdo con las regulaciones de las directivas 2006/42/EG, 2014/30/EU, 2011/65/EU

(I) CE-'17 - Dichiarazione di conformità. Dichiariamo sotto la nostra esclusiva responsabilità che questo prodotto è conforme alle seguenti norme e documenti normativi: EN 62841-1, EN ISO 12100, EN ISO 13857, EN 349, EN 28662-1, EN 61000-6-3, EN 61000-6-2, EN 60529, EN 1037 conformemente alle disposizioni delle direttive 2006/42/EG, 2014/30/EU, 2011/65/EU

(P) CE-'17 - Declaração de conformidade. Declaramos sob nossa exclusiva responsabilidade que este produto cumpre as seguintes normas ou documentos normativos: EN 62841-1, EN ISO 12100, EN ISO 13857, EN 349, EN 28662-1, EN 61000-6-3, EN 61000-6-2, EN 60529, EN 1037 conforme as disposições das directivas 2006/42/EG, 2014/30/EU, 2011/65/EU

(NL) CE-'17 - Konformiteitsverklaring. Wij verklaren en wij stellen ons er alleen voor verantwoordelijk dat dit product voldoet aan de volgende normen of normatieve documenten: EN 62841-1, EN ISO 12100, EN ISO 13857, EN 349, EN 28662-1, EN 61000-6-3, EN 61000-6-2, EN 60529, EN 1037 overeenkomstig de bepalingen van de richtlijnen 2006/42/EG, 2014/30/EU, 2011/65/EU

(GR) CE-'17 - ΔΗΛΩΣΗ ΣΥΜΜΟΡΦΩΣΗΣ Με αναληψη συλλογικης δηλωνομε: οτι το πορον προιον συμφορει με τα παρακατω ποστυπα και με τα ηροτυπα που αναφερουνται στα σχετικα εγγραφα. EN 62841-1, EN ISO 12100, EN ISO 13857, EN 349, EN 28662-1, EN 61000-6-3, EN 61000-6-2, EN 60529, EN 1037 συμφωνα με τοχς κοινοισμους 2006/42/EG, 2014/30/EU, 2011/65/EU

(S) CE-'17 - Konformitetsdeklaration. Vi förklarar på eget ansvar att denna produkt överensstämmer med följande normer eller normativa dokument: EN 62841-1, EN ISO 12100, EN ISO 13857, EN 349, EN 28662-1, EN 61000-6-3, EN 61000-6-2, EN 60529, EN 1037 enligt bestämmelserna i direktiverna 2006/42/EG, 2014/30/EU, 2011/65/EU

(DK) CE-'17 - Konformitetserklæring. Vi erklærer under almindeligt ansvar at dette produkt er i overensstemmelse med følgende normer eller normative dokumenter: EN 62841-1, EN ISO 12100, EN ISO 13857, EN 349, EN 28662-1, EN 61000-6-3, EN 61000-6-2, EN 60529, EN 1037 i henhold til bestemmelserne i direktiverne 2006/42/EØF, 2014/30/EU, 2011/65/EU

(N) CE-'17 - Konformitetserklæring. Vi erklærer på eget ansvarlighet at dette produkt er i overensstemmelse med følgende standarder eller standard-dokumenter: EN 62841-1, EN ISO 12100, EN ISO 13857, EN 349, EN 28662-1, EN 61000-6-3, EN 61000-6-2, EN 60529, EN 1037 i henhold til bestemmelserne i direktive ne 2006/42/EØF, 2014/30/EU, 2011/65/EU

(FIN) CE-'17 - Todistus standardinmukaissuudesta. Asiaasta vastaavana todistamme täten, että tämä tuote on seuraavien standardien ja standardoimisasiakirjojen vaatimusten mukainen: EN 62841-1, EN ISO 12100, EN ISO 13857, EN 349, EN 28662-1, EN 61000-6-3, EN 61000-6-2, EN 60529, EN 1037 ja vastaa säädöksiä 2006/42/EG, 2014/30/EU, 2011/65/EU

(SK) CE-'17 - Prehlásenie o zhode. Prehlasujeme na vlastnú zodpovednosť, že tieto produkty sú v súlade s nasledovnými normami: EN 62841-1, EN ISO 12100, EN ISO 13857, EN 349, EN 28662-1, EN 61000-6-3, EN 61000-6-2, EN 60529, EN 1037 a v zhode so smernicami 2006/42/EG, 2014/30/EU, 2011/65/EU

(PL) CE-'17 - Zgodność z dyrektywami CE. Świadomy odpowiedzialności oświadczamy, że niniejszy produkt jest zgodny z następującymi normami lub dokumentacją normatywną: EN 62841-1, EN ISO 12100, EN ISO 13857, EN 349, EN 28662-1, EN 61000-6-3, EN 61000-6-2, EN 60529, EN 1037 zgodnie z postanowieniami wytycznych 2006/42/EG, 2014/30/EU, 2011/65/EU

(CZ) CE-'17 - Prohlášení o shode. Prohlasujeme na vlastní zodpovednosť, že tyto produkty splňují následující normy nebo normativní listiny: EN 62841-1, EN ISO 12100, EN ISO 13857, EN 349, EN 28662-1, EN 61000-6-3, EN 61000-6-2, EN 60529, EN 1037; Ve shode se smernicami 2006/42/EG, 2014/30/EU, 2011/65/EU

(SLO) CE-'17 - Izjava o skladnosti. S tem potrjujemo splošno odgovornost, da je ta izdelek narejen v skladu z navedenimi normami in standardi: EN 62841-1, EN ISO 12100, EN ISO 13857, EN 349, EN 28662-1, EN 61000-6-3, EN 61000-6-2, EN 60529, EN 1037 ter določbami in smernicami 2006/42/EG, 2014/30/EU, 2011/65/EU

(HR) CE-'17 - Izjava o skladnosti. Pod punom odgovornošću izjavljujemo da je proizvod naveden u naslovu ovog dokumenta sukladan sa primijenjenim normama i normativnim dokumentima: EN 62841-1, EN ISO 12100, EN ISO 13857, EN 349, EN 28662-1, EN 61000-6-3, EN 61000-6-2, EN 60529, EN 1037 u skladu sa odredbama preporuka 2006/42/EG, 2014/30/EU, 2011/65/EU

(H) CE-'17 - Megfelelősségi nyilatkozat. Kéziműkötetésű elektromos kéziszerszámok: Teljes felelősséggel kijelentjük, hogy ezek a termékek a következő szabványokkal és irányelvekkel összhangban vannak: EN 62841-1, EN ISO 12100, EN ISO 13857, EN 349, EN 28662-1, EN 61000-6-3, EN 61000-6-2, EN 60529, EN 1037; és megfelelnek a rendeltetés szerinti 2006/42/EG, 2014/30/EU, 2011/65/EU irányelveknek.

(RO) CE-'17 - Declarație de conformitate. Noi declarăm pe propria răspundere că acest produs este în conformitate cu următoarele norme și documente normative: EN 62841-1, EN ISO 12100, EN ISO 13857, EN 349, EN 28662-1, EN 61000-6-3, EN 61000-6-2, EN 60529, EN 1037; potrivit dispozițiilor directivelor 2006/42/EG, 2014/30/EU, 2011/65/EU

Remscheid, den 02.11.2017



Joh. - Christoph Schütz

Dipl.-Ing. Joh.-Christoph Schütz, CE-Beauftragter

Handgeführtes batteriebetriebenes Elektrowerkzeug Typ ES 32RMCCFM

Klauke

- (D) CE-'17 - Konformitätserklärung RED. Wir erklären in alleiniger Verantwortlichkeit, daß dieses Produkt mit den folgenden Normen oder normativen Dokumenten übereinstimmt: EN 60950-1, EN 301489-1, EN 301489-17, EN 300328 V2.1.1, EN 62479 gemäß den Bestimmungen der Richtlinien 2014/53/EU, 2011/65/EU
- (GB) CE-'17 - Declaration of conformity RED. We declare under our sole responsibility that this product is in conformity with the following standards or normative documents: EN 60950-1, EN 301489-1, EN 301489-17, EN 300328 V2.1.1, EN 62479 in accordance with the regulations of directives 2014/53/EU, 2011/65/EU
- (F) CE-'17 - Déclaration de conformité RED. Nous déclarons sous notre seule responsabilité que ce produit est en conformité avec les normes ou documents normatifs suivants: EN 60950-1, EN 301489-1, EN 301489-17, EN 300328 V2.1.1, EN 62479 conformément aux réglementations des directives 2014/53/EU, 2011/65/EU
- (E) CE-'17 - Declaración de conformidad RED. Declaramos bajo nuestra sola responsabilidad que este producto está en conformidad con las normas o documentos normativos siguientes: EN 60950-1, EN 301489-1, EN 301489-17, EN 300328 V2.1.1, EN 62479 de acuerdo con las regulaciones de las directivas 2014/53/EU, 2011/65/EU
- (I) CE-'17 - Dichiarazione di conformità RED. Dichiariamo sotto la nostra esclusiva responsabilità che questo prodotto è conforme alle seguenti norme e documenti normativi: EN 60950-1, EN 301489-1, EN 301489-17, EN 300328 V2.1.1, EN 62479 conformemente alle disposizioni delle direttive 2014/53/EU, 2011/65/EU
- (P) CE-'17 - Declaração de conformidade RED. Declaramos sob nossa exclusiva responsabilidade que este producto cumpre as seguintes normas ou documentos normativos: EN 60950-1, EN 301489-1, EN 301489-17, EN 300328 V2.1.1, EN 62479 conforme as disposições das directivas 2014/53/EU, 2011/65/EU
- (NL) CE-'17 - Konformiteitsverklaring RED. Wij verklaren en wij stellen ons er alleen voor verantwoordelijk dat dit produkt voldoet aan de volgende normen of normatieve documenten: EN 60950-1, EN 301489-1, EN 301489-17, EN 300328 V2.1.1, EN 62479 overeenkomstig de bepalingen van de richtlijnen 2014/53/EU, 2011/65/EU
- (GR) CE-'17 - ΔΗΛΩΣΗ ΣΥΜΜΟΡΦΩΣΗΣ Μ RED. ϵ αναληψη συνολικης δηλωσιμε: οτι το πορον προιον συμφορει με τα παρακατω ποοτυνα και με τα ηροτυνη ηου αναφερονται στα σχετικα εγγραφα ∞ EN 60950-1, EN 301489-1, EN 301489-17, EN 300328 V2.1.1, EN 62479 σύμφωνα με τοxα κοινουτομοιοs 2014/53/EU, 2011/65/EU
- (S) CE-'17 - Konformitetsdeklaration RED. Vi förklarar på eget ansvar att denna produkt överensstämmer med följande normer eller normativa dokument: EN 60950-1, EN 301489-1, EN 301489-17, EN 300328 V2.1.1, EN 62479 enligt bestämmelserna i direktiverna 2014/53/EU, 2011/65/EU
- (DK) CE-'17 - Konformitetserklæring RED. Vi erklærer under almindeligt ansvar at dette produkt er i overensstemmelse med følgende normer eller normative dokumenter: EN 60950-1, EN 301489-1, EN 301489-17, EN 300328 V2.1.1, EN 62479 i henhold til bestemmelserne i direktivene 2014/53/EU, 2011/65/EU
- (N) CE-'17 - Konformitetserklæring RED. Vi erklærer på eget ansvar for at dette produkt er i overensstemmelse med følgende standarder eller standard-dokumenter: EN 60950-1, EN 301489-1, EN 301489-17, EN 300328 V2.1.1, EN 62479 i henhold til bestemmelserne i direktivene 2014/53/EU, 2011/65/EU
- (FIN) CE-'17 - Todistus standardinmukaisuudesta RED. Asiasta vastaavana todistamme läten, että tämä tuote on seuraavien standardien ja standardoimisasiakirjojen vaatimusten mukainen: EN 60950-1, EN 301489-1, EN 301489-17, EN 300328 V2.1.1, EN 62479 ja vastaa säädöksiä 2014/53/EU, 2011/65/EU
- (SK) CE-'17 - Prehlásenie o zhode RED. Prehlasujeme na vlastnú zodpovednosť, že tieto produkty sú v súlade s nasledovnými normami: EN 60950-1, EN 301489-1, EN 301489-17, EN 300328 V2.1.1, EN 62479 a v zhode so smernicami 2014/53/EU, 2011/65/EU
- (PL) CE-'17 - Zgodność z dyrektywami RED. Świadomi odpowiedzialności oświadczamy, że niniejszy produkt jest zgodny z następującymi normami lub dokumentacja normatywna: EN 60950-1, EN 301489-1, EN 301489-17, EN 300328 V2.1.1, EN 62479 zgodnie z postanowieniami wytycznych 2014/53/EU, 2011/65/EU
- (CZ) CE-'17 - Prohlášení o shodě RED. Prohlasujeme na vlastní zodpovednosť, že tyto produkty splňují následující normy nebo normativní listiny: EN 60950-1, EN 301489-1, EN 301489-17, EN 300328 V2.1.1, EN 62479 Ve shodě se směrnicemi 2014/53/EU, 2011/65/EU
- (SLO) CE-'17 - Izjava o skladnosti RED. S tem potrjujemo splošno odgovornost, da je ta izdelek narejen v skladu z navedenimi normami in standardi EN 60950-1, EN 301489-1, EN 301489-17, EN 300328 V2.1.1, EN 62479 ter določbami in smernicami 2014/53/EU, 2011/65/EU
- (HR) CE-'17 - Izjava o skladnosti RED. Pod punom odgovornošću izjavljujemo da je proizvod naveden u naslovu ovog dokumenta skladan sa primijenjenim normama i normativnim dokumentima : EN 60950-1, EN 301489-1, EN 301489-17, EN 300328 V2.1.1, EN 62479 u skladu sa odredbama preporuka 2014/53/EU, 2011/65/EU
- (H) CE-'17 - Megfelelőségi nyilatkozat RED. Kéziműködtetésű elektromos kéziszerszámok. Teljes felelősséggel kijelentjük, hogy ezek a termékek a következő szabványokkal és irányelvekkel összhangban vannak: EN 60950-1, EN 301489-1, EN 301489-17, EN 300328 V2.1.1, EN 62479 és megfelelnek a rendeltetés 2014/53/EU, 2011/65/EU irányelveknek.
- (RO) CE-'17 - Declarație de conformitate RED. Noi declarăm pe propria răspundere că acest produs este în conformitate cu următoarele norme și documente normative: EN 60950-1, EN 301489-1, EN 301489-17, EN 300328 V2.1.1, EN 62479 potrivit dispozițiilor directivelor 2014/53/EU, 2011/65/EU

CE

Joh. - Christoph Schütz

Dipl.-Ing. Joh.-Christoph Schütz, CE-Beauftragter

Remscheid, den 01.11.2017

Handgeführtes batteriebetriebenes Elektrowerkzeug Typ ES 32RMCCFM

Klauke

(D) UKCA-21 - Konformitätserklärung. Wir erklären in alleiniger Verantwortlichkeit, daß dieses Produkt mit den folgenden Normen oder normativen Dokumenten übereinstimmt: BS EN 62841-1, BS EN ISO 12100, BS EN ISO 13857, BS EN 349, BS EN 28662-1, BS EN 61000-6-3, BS EN 61000-6-2, BS EN 1037 gemäß den Bestimmungen der Richtlinien 2006/42/EG, 2014/30/EU, 2011/65/EU

RED: BS EN IEC 62368-1, EN 301489-1, EN 301489-17, EN 300328 V2.2.2, BS EN 62479 gemäß den Bestimmungen der Richtlinien 2014/53/EU, 2011/65/EU

(GB) UKCA-21 - Declaration of conformity. We declare under our sole responsibility that this product is in conformity with the following standards or normative documents: BS EN 62841-1, BS EN ISO 12100, BS EN ISO 13857, BS EN 349, BS EN 28662-1, BS EN 61000-6-3, BS EN 61000-6-2, BS EN 1037 in accordance with the regulations of directives 2006/42/EG, 2014/30/EU, 2011/65/EU

RED: BS EN IEC 62368-1, EN 301489-1, EN 301489-17, EN 300328 V2.2.2, BS EN 62479 in accordance with the regulations of directives 2014/53/EU, 2011/65/EU

(F) UKCA-21 - Déclaration de conformité. Nous déclarons sous notre seule responsabilité que ce produit est en conformité avec les normes ou documents normatifs suivants: BS EN 62841-1, BS EN ISO 12100, BS EN ISO 13857, BS EN 349, BS EN 28662-1, BS EN 61000-6-3, BS EN 61000-6-2, BS EN 1037 conformément aux réglementations des directives 2006/42/EG, 2014/30/EU, 2011/65/EU

RED: BS EN IEC 62368-1, EN 301489-1, EN 301489-17, EN 300328 V2.2.2, BS EN 62479 conformément aux réglementations des directives 2014/53/EU, 2011/65/EU

(E) UKCA-21 - Declaración de conformidad. Declaramos bajo nuestra sola responsabilidad que este producto está en conformidad con las normas o documentos normativos siguientes: BS EN 62841-1, BS EN ISO 12100, BS EN ISO 13857, BS EN 349, BS EN 28662-1, BS EN 61000-6-3, BS EN 61000-6-2, BS EN 1037 de acuerdo con las regulaciones de las directivas 2006/42/EG, 2014/30/EU, 2011/65/EU

RED: BS EN IEC 62368-1, EN 301489-1, EN 301489-17, EN 300328 V2.2.2, BS EN 62479 de acuerdo con las regulaciones de las directivas 2014/53/EU, 2011/65/EU

(I) UKCA-21 - Dichiarazione di conformità. Dichiariamo sotto la nostra esclusiva responsabilità che questo prodotto è conforme alle seguenti norme e documenti normativi: BS EN 62841-1, BS EN ISO 12100, BS EN ISO 13857, BS EN 349, BS EN 61000-6-3, BS EN 61000-6-2, BS EN 1037 conformemente alle disposizioni delle direttive 2006/42/EG, 2014/30/EU, 2011/65/EU

RED: BS EN IEC 62368-1, EN 301489-1, EN 301489-17, EN 300328 V2.2.2, BS EN 62479 conformemente alle disposizioni delle direttive 2014/53/EU, 2011/65/EU

(P) UKCA-21 - Declaração de conformidade. Declaramos sob nossa exclusiva responsabilidade que este produto cumpre as seguintes normas ou documentos normativos: BS EN 62841-1, BS EN ISO 12100, BS EN ISO 13857, BS EN 349, BS EN 28662-1, BS EN 61000-6-3, BS EN 61000-6-2, BS EN 1037 conforme as disposições das directivas 2006/42/EG, 2014/30/EU, 2011/65/EU

RED: BS EN IEC 62368-1, EN 301489-1, EN 301489-17, EN 300328 V2.2.2, BS EN 62479 conforme as disposições das directivas 2014/53/EU, 2011/65/EU

(NL) UKCA-21 - Konformiteitsverklaring. Wij verklaren en wij stellen ons er alleen voor verantwoordelijk dat dit product voldoet aan de volgende normen of normatieve documenten: BS EN 62841-1, BS EN ISO 12100, BS EN ISO 13857, BS EN 349, BS EN 28662-1, BS EN 61000-6-3, BS EN 61000-6-2, BS EN 1037 overeenkomstig de bepalingen van de richtlijnen 2006/42/EG, 2014/30/EU, 2011/65/EU

RED: BS EN IEC 62368-1, EN 301489-1, EN 301489-17, EN 300328 V2.2.2, BS EN 62479 overeenkomstig de bepalingen van de richtlijnen 2014/53/EU, 2011/65/EU

(GR) UKCA-21 - Δήλωση Συμμόρφωσης. Με αλληλεπίσυντατική δήλωση μας - ότι το παρόν προϊόν συμμορφώνεται με τα παρακάτω πρότυπα και με τα πρότυπα που αναφέρονται στα σχετικά έγγραφα BS EN 62841-1, BS EN ISO 12100, BS EN ISO 13857, BS EN 349, BS EN 28662-1, BS EN 61000-6-3, BS EN 61000-6-2, BS EN 1037 σύμφωνα με τους κανονισμούς 2006/42/EG, 2014/30/EU, 2011/65/EU

RED: BS EN IEC 62368-1, EN 301489-1, EN 301489-17, EN 300328 V2.2.2, BS EN 62479 σύμφωνα με τους κανονισμούς 2014/53/EU, 2011/65/EU

(S) UKCA-21 - Konformitetsdeklaration. Vi förklarar på eget ansvar att denna produkt överensstämmer med följande normer eller normativa dokument: BS EN 62841-1, BS EN ISO 12100, BS EN ISO 13857, BS EN 349, BS EN 28662-1, BS EN 61000-6-3, BS EN 61000-6-2, BS EN 1037 enligt bestämmelserna i direktiverna 2006/42/EG, 2014/30/EU, 2011/65/EU

RED: BS EN IEC 62368-1, EN 301489-1, EN 301489-17, EN 300328 V2.2.2, BS EN 62479 enligt bestämmelserna i direktiverna 2014/53/EU, 2011/65/EU

(DK) UKCA-21 - Konformitetserklæring. Vi erklærer under almindeligt ansvar at dette produkt er i overensstemmelse med følgende normer eller normative dokumenter: BS EN 62841-1, BS EN ISO 12100, BS EN ISO 13857, BS EN 349, BS EN 28662-1, BS EN 61000-6-3, BS EN 61000-6-2, BS EN 1037 i henhold til bestemmelserne i direktivene 2006/42/EG, 2014/30/EU, 2011/65/EU

RED: BS EN IEC 62368-1, EN 301489-1, EN 301489-17, EN 300328 V2.2.2, BS EN 62479 i henhold til bestemmelserne i direktivene 2014/53/EU, 2011/65/EU

(N) UKCA-21 - Konformitetserklæring. Vi erklærer på eget ansvarlighet at dette produkt er i overensstemmelse med følgende standarder eller standard-dokumenter: BS EN 62841-1, BS EN ISO 12100, BS EN ISO 13857, BS EN 349, BS EN 28662-1, BS EN 61000-6-3, BS EN 61000-6-2, BS EN 1037 i henhold til bestemmelserne i direktive ne 2006/42/EG, 2014/30/EU, 2011/65/EU

RED: BS EN IEC 62368-1, EN 301489-1, EN 301489-17, EN 300328 V2.2.2, BS EN 62479 i henhold til bestemmelserne i direktive ne 2014/53/EU, 2011/65/EU

(FI) UKCA-21 - Todistus standardinmukaaisuudesta. Asiasta vastaavana todistamme lähten, että tämä tuote on seuraavien standardien ja standardomissa kirjien vaatimusten mukainen: BS EN 62841-1, BS EN ISO 12100, BS EN ISO 13857, BS EN 349, BS EN 28662-1, BS EN 61000-6-3, BS EN 61000-6-2, BS EN 1037 ja vastaa säädöksiä 2006/42/EG, 2014/30/EU, 2011/65/EU

RED: BS EN IEC 62368-1, EN 301489-1, EN 301489-17, EN 300328 V2.2.2, BS EN 62479 ja vastaa säädöksiä 2014/53/EU, 2011/65/EU

(SK) UKCA-21 - Prehlásenie o zhode. Prehlasujeme na vlastnú zodpovednosť, že tieto produkty sú v súlade s nasledovnými normami: BS EN 62841-1, BS EN ISO 12100, BS EN ISO 13857, BS EN 349, BS EN 28662-1, BS EN 61000-6-3, BS EN 61000-6-2, BS EN 1037 a v zhode so smernicami 2006/42/EG, 2014/30/EU, 2011/65/EU

RED: BS EN IEC 62368-1, EN 301489-1, EN 301489-17, EN 300328 V2.2.2, BS EN 62479 a v zhode so smernicami 2014/53/EU, 2011/65/EU

(PL) UKCA-21 - Zgodność z dyrektywami UKCA. Świadcimy odpowiedzialności oświadczamy, że niniejszy produkt jest zgodny z następującymi normami lub dokumentacją normatywną: BS EN 62841-1, BS EN ISO 12100, BS EN ISO 13857, BS EN 349, BS EN 28662-1, BS EN 61000-6-3, BS EN 61000-6-2, BS EN 1037 zgodnie z postanowieniami wytycznych 2006/42/EG, 2014/30/EU, 2011/65/EU

RED: BS EN IEC 62368-1, EN 301489-1, EN 301489-17, EN 301489-17, EN 300328 V2.2.2, BS EN 62479 zgodnie z postanowieniami wytycznych 2014/53/EU, 2011/65/EU

(CZ) UKCA-21 - Prohlášení o shodě. Prohlasujeme na vlastní zodpovědnost, že tyto produkty splňují následující normy nebo normativní listiny: BS EN 62841-1, BS EN ISO 12100, BS EN ISO 13857, BS EN 349, BS EN 28662-1, BS EN 61000-6-3, BS EN 61000-6-2, BS EN 1037. Ve shodě se směrnicemi 2006/42/EG, 2014/30/EU, 2011/65/EU

RED: BS EN IEC 62368-1, EN 301489-1, EN 301489-17, EN 300328 V2.2.2, BS EN 62479 ve shodě se směrnicemi 2014/53/EU, 2011/65/EU

(SLO) UKCA-21 - Izjava o skladnosti. S tem potrjujemo splošno odgovornost, da je ta izdelek shoden v skladu z navedenimi normami in standardi: BS 62841-1, BS ISO 12100, BS ISO 13857, BS 349, BS 28662-1, BS EN 61000-6-3, BS EN 61000-6-2, BS EN 1037 ter določbami in smernicami 2006/42/EG, 2014/30/EU, 2011/65/EU

RED: BS EN IEC 62368-1, EN 301489-1, EN 301489-17, EN 300328 V2.2.2, BS EN 62479 ter določbami in smernicami 2014/53/EU, 2011/65/EU

(HR) UKCA-21 - Izjava o skladnosti. Pod punom odgovornošću izjavljujemo da je proizvod naveden u naslovu ovog dokumenta skladan sa primjenjivim normama i normativnim dokumentima: BS EN 62841-1, BS EN ISO 12100, BS EN ISO 13857, BS EN 349, BS EN 28662-1, BS EN 61000-6-3, BS EN 61000-6-2, BS EN 1037 u skladu sa odredbama preporuka 2006/42/EG, 2014/30/EU, 2011/65/EU

RED: BS EN IEC 62368-1, EN 301489-1, EN 301489-17, EN 300328 V2.2.2, BS EN 62479 u skladu sa odredbama preporuka 2014/53/EU, 2011/65/EU

(H) UKCA-21 - Megfelelőségi nyilatkozat. Kéziműködetésű elektromos kéziszerszámok: Teljes felelősséggel kijelentjük, hogy ezek a termékek a következő szabványokkal és irányelvekkel összhangban vannak: BS EN 62841-1, BS EN ISO 12100, BS EN ISO 13857, BS EN 349, BS EN 28662-1, BS EN 61000-6-3, BS EN 61000-6-2, BS EN 1037; és megfelelnek a rendeltetés szerinti 2006/42/EG, 2014/30/EU, 2011/65/EU irányelveknek.

RED: BS EN IEC 62368-1, EN 301489-1, EN 301489-17, EN 300328 V2.2.2, BS EN 62479 és megfelelnek a rendeltetés 2014/53/EU, 2011/65/EU irányelveknek.

(RO) UKCA-21 - Declarație de conformitate. Noi declarăm pe propria răspundere că acest produs este în conformitate cu următoarele norme și documente normative: BS EN 62841-1, BS EN ISO 12100, BS EN ISO 13857, BS EN 349, BS EN 28662-1, BS EN 61000-6-3, BS EN 61000-6-2, BS EN 1037; potrivit dispozitiilor directivelor 2006/42/EG, 2014/30/EU, 2011/65/EU

RED: BS EN IEC 62368-1, EN 301489-1, EN 301489-17, EN 300328 V2.2.2, BS EN 62479 potrivit dispozitiilor directivelor 2014/53/EU, 2011/65/EU

Remscheid, 25.06.2021



Joh. - Christoph Schütz

Dipl.-Ing. Joh.-Christoph Schütz, CE-Representative